



**PRM-91H  
 PRM-92H  
 PRM-2H**

**Plug-in time relay**



**Characteristic**

- equivalent of modular types of relays but in versions for 11 or 8 pin standardized socket
- plug-in type enables easy exchange, replacement of older types of relays (pin compatible) or easy exchange of an auxiliary relay for a timer
- Multifunction time relay PRM-91H
  - 11 and 8 pin version
  - 10 time functions, time scale 0.1 s - 10 days divided into 10 ranges: 0.1 s-1 s / 1 s-10 s / 0.1 min-1 min / 1 min-10 min / 0.1 hrs-1 hrs / 1 hrs-10 hrs / 0.1 day-1 day / 1 day-10 days / only ON / only OFF
  - output contact 1x 16 A / 4000 VA, 250 V AC1
- Multifunction time relay PRM-92H
  - 11 pin version
  - 10 time functions, time scale 0.1 s - 10 days divided into 10 ranges: 0.1 s-1 s / 1 s-10 s / 0.1 min-1 min / 1 min-10 min / 0.1 hrs-1 hrs / 1 hrs-10 hrs / 0.1 day-1 day / 1 day-10 days / only ON / only OFF
  - output contact 2x 8 A / 2000 VA, 250 V AC1
- Asymmetric cycler PRM-2H
  - 11 pin version
  - 2 time functions, time scale 0.1 s - 100 days divided into 10 ranges: 0.1 s-1 s / 1 s-10 s / 0.1 min-1 min / 1 min-10 min / 0.1 hrs-1 hrs / 1 hrs-10 hrs / 0.1 day-1 day / 1 day-10 days / 3 days-30 days / 10 days-100 days
  - output contact 2x 8 A / 2000 VA, 250 V AC1
- universal supply voltage AC/DC 12 - 240 V
- output indication: multif. red LED, which is flashing or shining according to an output status
- PLUG-IN version, relays into a socket

**Symbol**

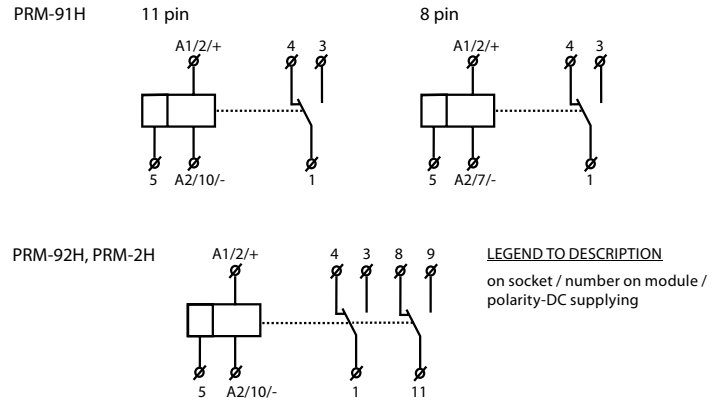

**Connection**

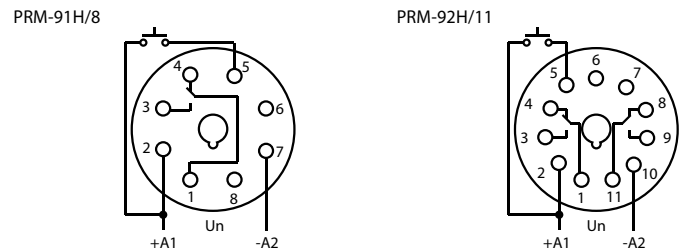

**Description**

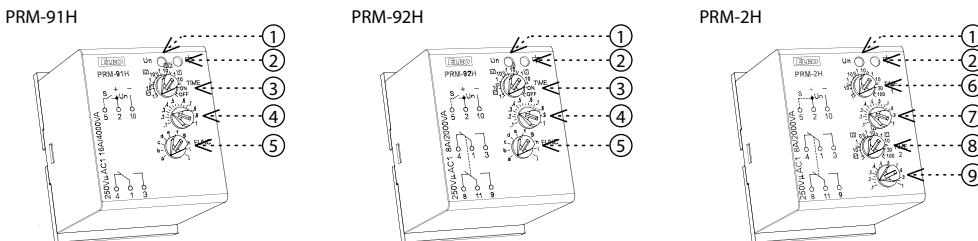

1. Supply voltage indication
2. Output indication
3. Rough adjusting of time
4. Slight adjusting of time
5. Function setting
6. Rough adjusting of time IMPULS
7. Slight adjusting of time IMPULS
8. Rough adjusting of time PAUSE
9. Slight adjusting of time PAUSE

**PRM-91H**

Type of load	$\cos \varphi \geq 0.95$								
mat. contacts AgNi, contact 16 A	250V / 16A	250V / 5A	250V / 3A	230V / 3A (690VA)	x	800W	x	250V / 3A	250V / 10A
Type of load									
mat. contacts AgNi, contact 16 A	250V / 6A	250V / 6A	250V / 6A	24V / 16A	24V / 6A	24V / 4A	24V / 16A	24V / 2A	24V / 2A

**PRM-92H, PRM-2H**

Type of load	$\cos \varphi \geq 0.95$								
mat. contacts AgNi, contact 8 A	250V / 8A	250V / 3A	250V / 2A	230V / 1.5A (345VA)	x	300W	x	250V / 1A	250V / 1A
Type of load									
mat. contacts AgNi, contact 8 A	x	250V / 3A	250V / 3A	24V / 8A	24V / 3A	24V / 2A	24V / 8A	24V / 2A	x

## Technical parameters

	PRM-91H/8	PRM-91H/11	PRM-92H	PRM-2H
Number of functions:	10			2
Supply:	pins 2 and 7	pins 2 and 10	pins 2 and 10	pins 2 and 10
Voltage range:	AC/DC 12 - 240 V (AC 50 - 60 Hz)			
Power input (max.):	AC 0.7 - 3 VA / DC 0.5 - 1.7 W			
Max. dissipated power (Un + terminals):	8 W	7 W	4 W	2 W
Supply voltage tolerance:	-15 %; +10 %			
Supply indication:	green LED			
Time ranges:	0.1 s - 10 days		0.1 s - 100 days	
Time setting:	rotary switch and potentiometer			
Time deviation:	5 % - mechanical setting			
Repeat accuracy:	0.2 % - set value stability			
Temperature coefficient:	0.01 % / °C, at = 20 °C (0.01 % / °F, at = 68 °F)			

### Output

	1x changeover / SPDT (AgNi / Silver Alloy)	2x changeover / DPDT (AgNi / Silver Alloy)
Current rating:	16 A / AC1	8 A / AC1
Breaking capacity:	4000 VA / AC1, 384 W / DC	2000 VA / AC1, 192 W / DC
Inrush current:	30 A / < 3 s	10 A / < 3 s
Switching voltage:	250 V AC1 / 24 V DC	
Output indication:	multifunction red LED	
Mechanical life:	3x10 <sup>7</sup>	
Electrical life (AC1):	0.7x10 <sup>5</sup>	

### Controlling

Control. voltage:	in the supply voltage range
Power the control input:	AC 0.025 - 0.2 VA / DC 0.1 - 0.7 W (UNI)
Load between 5-10:	Yes
Glow tubes connetions:	No
Control terminals:	2 - 5
Max. capacity of cable control: - without connected glow-lamps:	0.1 μF
Impulse length:	min. 25 ms / max. unlimited
Reset time:	max. 150 ms

### Other information

Operating temperature:	-20 .. 55 °C (-4 °F .. 131 °F)			
Storage temperature:	-30 .. 70 °C (-22 °F .. 158 °F)			
Electrical strength:	2.5 kV			
Operating position:	any			
Mounting / DIN rail:	DIN rail EN 60715			
Protection degree:	IP40 from front panel			
Overvoltage category:	III.			
Pollution degree:	2			
Dimensions:	50 x 38 x 51 mm (2" x 1.5" x 2")			
Weight:	54 g (1.9 oz.)	58 g (2.05 oz.)	58 g (2.05 oz.)	59 g (2.08 oz.)
Standards:	EN 61812-1, EN 61010-1			

## Recommended socket for DIN rail

Max. current: 10 A

ES-11 (11 pin)

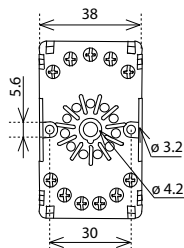

ES-8 (8 pin)

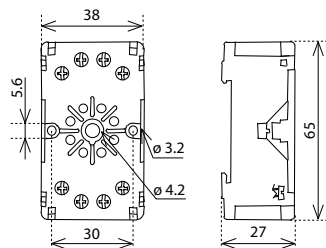

## Functions

PRM-91H, PRM-92H

Delay ON after energisation



Delay OFF after energisation

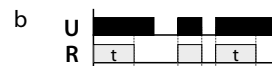

Cycler beginning with pause after energisation

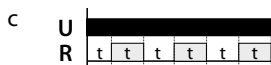

Cycler beginning with impulse after energisation

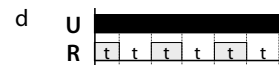

Delay OFF after de-energisation, instant make of output

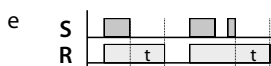

Delay OFF responding to make of control contact regardless its length

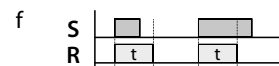

Delay OFF after break of control contact with instant output

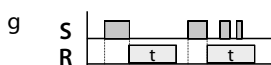

Delay OFF after make and break of control contact

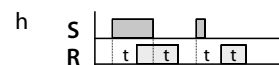

Impulse relay

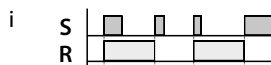

Pulse generator (puls = 0.5s)

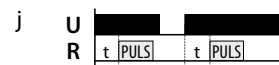

PRM-2H

By PRM-2H function is selected by connecting by terminals 2 and 5.

Cycler beginning with impulse

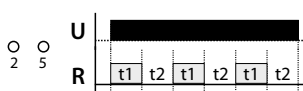

Cycler beginning with pause

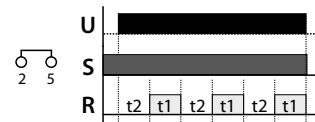

## Warning

Device is constructed for connection in 1-phase main alternating current and must be installed according to norms valid in the state of application. Connection according to the details in this direction. Installation, connection, setting and servicing should be installed by qualified electrician staff only, who has learnt these instruction and functions of the device. This device contains protection against overvoltage peaks and disturbances in supply. For correct function of the protection of this device there must be suitable protections of higher degree (A, B, C) installed in front of them. According to standards elimination of disturbances must be ensured. Before installation the main switch must be in position "OFF" and the device should be de-energized. Don't install the device to sources of excessive electro-magnetic interference. By correct installation ensure ideal air circulation so in case of permanent operation and higher ambient temperature the maximal operating temperature of the device is not exceeded. For installation and setting use screw-driver cca 2 mm. The device is fully-electronic - installation should be carried out according to this fact. Non-problematic function depends also on the way of transportation, storing and handling. In case of any signs of destruction, deformation, non-function or missing part, don't install and claim at your seller. In case of any signs of destruction, deformation, non-function or missing part, don't install and claim at your seller. It is possible to dismount the device after its lifetime, recycle, or store in protective dump.