

BUS

Wired electro-installation



About us

ELKO EP have been your partner in the field for 31 years, developing and manufacturing the highest quality electronic devices for electroinstallation as well as smart system for residential and building automation.

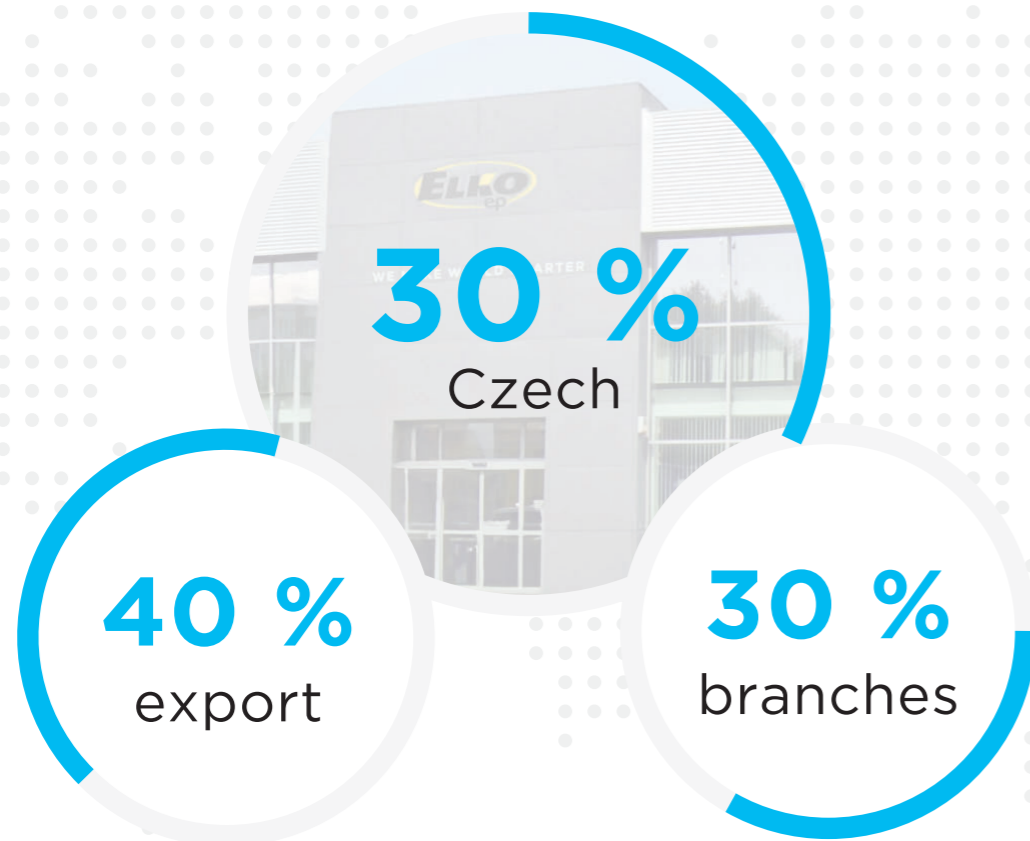

ELKO EP employs more than 330 people across 15 foreign branches and exports its products to more than seventy countries. Company of the Year, Visionary of the Year, Superbrands and Global Exporter of the Year are just some of the awards we have received throughout the years as we consistently strive to move forward in the field of innovation and development.

Millions of relays, thousands of smart homes, hundreds of buildings and many satisfied customers - This is ELKO EP; a traditional company based in the center of Europe, where own development, production, logistics, and service are at the forefront of our focus.

Facts and stats

WORLDWIDE

11 branches
6 franchises
70 export countries

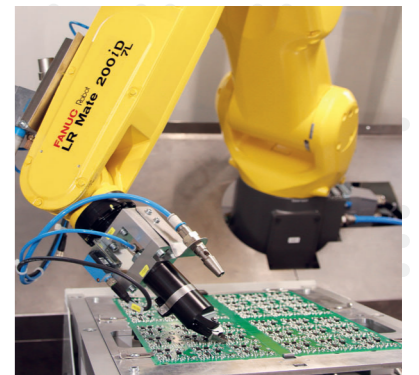

WE MAKE WORLD SMARTER

www.elkoep.com



Revolutionizing building automation: Exploring the new iNELS bus architecture 6

iNELS topology 8

Overview of system units 10

Central units

CU3-08M | Central unit with 2x BUS 14

CU3-09M/DALI | Central unit with 1x BUS, 1x DALI - **NEW!** 15

CU3-10M/MODBUS | Central unit with 1x BUS, 1x MODBUS - **NEW!** 16

iNELS Bridge | Third-party integration gateway - **NEW!** 17

System units

PS3-30/iNELS | Power supply with BUS separator 18

PS3-30/DALI | Power Supply with BUS separator integrated with DALI Power Supply - **NEW** 19

BPS3-01M, BPS3-02M | Bus separator from power supply 20

PSM3-30/iNELS, PSM3-60/iNELS, PSM3-100/iNELS | Power supplies for iNELS BUS 21

Detectors | sensors

MCD3-1 | Ultra slim microwave motion detector - ceiling mount - **NEW!** 23

PMS3-1 | Ultra slim PIR motion detector - ceiling mount - **NEW!** 24

DLS3-1 | Light intensity sensor 25

Converters

IBWL3-xxB-SL | iNELS BUS wireless link - **NEW!** 26

ADC3-60M | Analog-to-digital converter, 6 inputs 27

DAC3-04M | Digital-to-analog converter, 4 outputs 28

DAC3-04B | Digital-analog converter 29

Switching actuators

SA3-01B, SA3-02B | Switching actuator, 1 channel and 2 channels 30

SA3-04M | Switching actuator, 4 channels 31

SA3-06M | Switching actuator, 6 channels 32

SA3-014M | Switching actuator, 14 channels - **NEW!** 33

SA3-014M/E | Switching actuator, 14 channels - **NEW!** 34

SA3-022M | Switching actuator, 22 channels 35

EA3-022M | Switching actuator without controls and indicators, 22 channels 36

Shutter actuators

JA3-014M | Shutter actuator, 14 channels - **NEW!** 37

JA3-014M/E | Shutter actuator, 14 channels - **NEW!** 38

Lighting control

DA3-22M | Universal dimming actuator, 2 channels 39

DA3-66M | Dimming actuator, 6 channels 40

DA3-03M/RGBW | Dimming actuator for RGBW strips 41

Input units

IM3-40B, IM3-80B | Binary input units, 4 inputs and 8 inputs 42

IM3-140M | Binary input unit, 14 inputs 43

TI3-40B | Temperature input, 4 inputs 44

TI3-60M | Temperature input, 6 inputs 45

Combined units

RC3-610M/DALI | Room controller with DALI dimmer - **NEW!** 46

FA3-612M | Fancoil controller 47

IOU3-108M | Universal unit with 10 inputs and 8 outputs 48

Wall controllers

WSB3-20, WSB3-20H | Wall switch button, 2 buttons 49

WSB3-40, WSB3-40H | Wall switch button, 4 buttons 50

WMR3-21 | Wall card reader 51

Glass controllers

GCR3-30, GCR3-230 | Glass card reader - **NEW!** 52

GSB3-XX, GSB3-2XX | Glass switch buttons - **NEW!** 54

GSB3-XX/S, GSB3-2XX/S | Glass switch buttons with symbols - **NEW!** 56

ZSB3-40, ZSB3-60, ZSB3-90 | Glass switch buttons - **NEW!** 58

Metal controllers

MSB3-40, MSB3-60, MSB3-90 | Metal switch buttons - **NEW!** 60

Glass socket panels / frames

..... 62

Metal sockets panels / frames

..... 63

Example Sockets / frames

..... 64

Icons configurator

..... 66

Thermo-regulators

IDRT3-1 | Digital room thermo-regulator 68

GRT3-70, GRT3-270 | Glass room thermo-regulator - **NEW!** 69

GRT3-100 | Glass room thermo-regulator - **COMING SOON!** 70

Integration

MQTT | The Standard for IoT Messaging 72

Multimedia

LARA Radio 74

LARA Intercom 75

LARA accessories 77

iNELS app

..... 78

Accessories iNELS

TELVA-2 230V, TELVA-2 24V | Thermo drive 80

TC, TZ, Pt100 | Thermo sensors 81

Inspinia touch units

Inspinia | Introduction - **NEW!** 84

INS45Q | 4" room control panel - **NEW!** 85

INS4RT | 4" room retrofit panel - **NEW!** 86

INS85Q | 8" touch control panel - **NEW!** 87

INS105Q | 10" touch control panel - **NEW!** 88

Add-ons 89

BUS electro-installation

..... 90

Product loadability 91

Loadability of contacts 93

Installation possibilities 94

Dimensions 96

In the rapidly evolving landscape of smart home and building automation, the iNELS Bus system is stepping into the spotlight with a groundbreaking new architecture. This innovative approach not only caters to the needs of independent units like villas and apartments but also scales seamlessly for large installations such as hotels and commercial buildings.

Autonomy Redefined: MiniCU Family

The introduction of the MiniCU family marks a significant shift, where each bus operates as a fully autonomous unit. This not only simplifies the system's structure but also ensures continuous functionality even if communication with other units is lost. MiniCU, short for Mini central units (CU3-08M/09M/10M), controls 1 or 2 buses, along with an additional bus for Dali/Modbus.

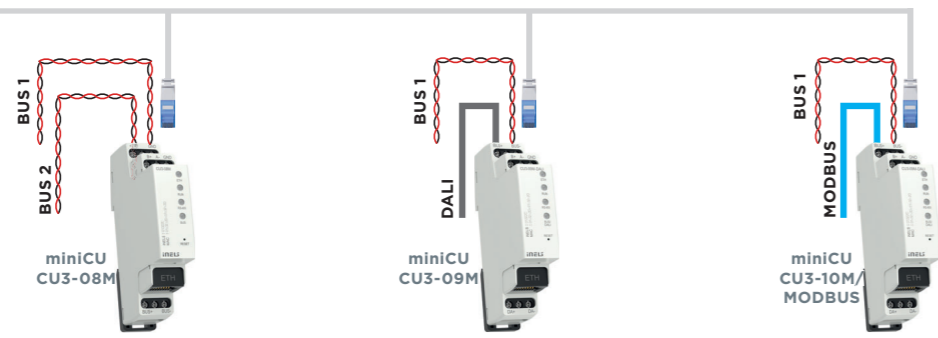

	CU3-08M	CU3-09M	CU3-10M/MODBUS
BUS1	✓	✓	✓
BUS2	✓		
DALI BUS		✓	
MODBUS			✓

Cloud Connectivity and Beyond

The new IP infrastructure elevates the iNELS Bus system to new heights. The connection to the central iNELS CLOUD system opens up possibilities for unlimited scaling. This cloud integration not only enables the coordination of units within a single installation but also facilitates inter-installation collaboration. Geographical barriers are broken down, allowing a control element in one location to manage devices in another, creating a truly interconnected network.

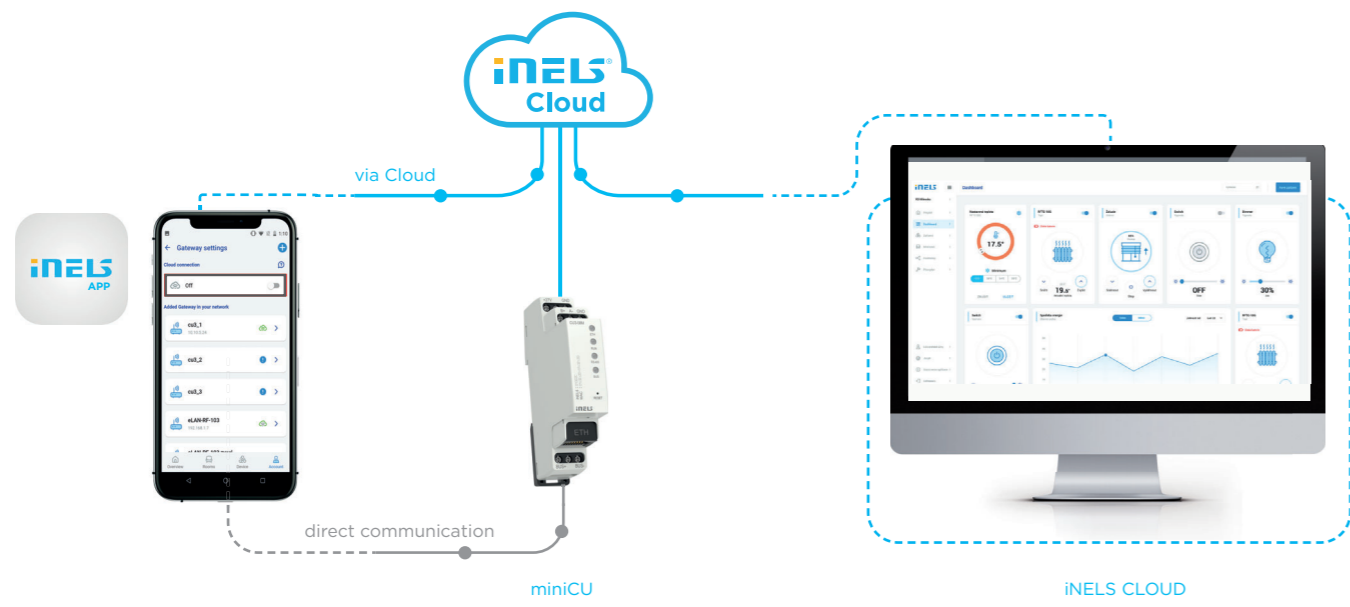

Power and Data Efficiency with MQTT

One of the standout features is the implementation of MQTT communication in all central units. MQTT, renowned for its fast response time, simplifies integration and control across the entire iNELS system with the 3rd Party world. This industry-standard protocol ensures efficient interaction between devices, regardless of the number in operation. The use of MQTT extends beyond the central units, reaching into both wired and wireless solutions, contributing to the overall energy efficiency and responsiveness of the system.

iNELS Bridge: Opening Doors to Third-Party Integration

Expanding its horizons, the new IP infrastructure includes the iNELS Bridge—a third-party integration control unit. This unit adds versatility by allowing almost the entire iNELS portfolio to be integrated, along with third-party devices using the Home Assistant platform. The pre-installation of MQTT broker and Home Assistant server for 3rd party integration makes iNELS Bridge not just a bridge but a comprehensive solution ready for diverse third-party integrations.

Centralized Control for Large Installations: Seamless Integration with Home Assistant and NodeRED

The iNELS Bus system recognizes the need for centralized control in large installations. This central control system acts as a hub, connecting and monitoring various iNELS devices, from sensors to controllers. The integration of communication protocols like MQTT and IP facilitates seamless data exchange, fostering a synchronized and harmonious operation. This adaptability of iNELS extends further with seamless integration capabilities with popular platforms like Home Assistant and NodeRED. This integration opens up a world of possibilities, allowing users to incorporate iNELS devices and functionalities into their existing smart home ecosystems. Whether it's custom automations, advanced scripting, or creating complex flows, the combination of iNELS with Home Assistant and NodeRED adds a layer of customization and control for users seeking a personalized smart home experience.

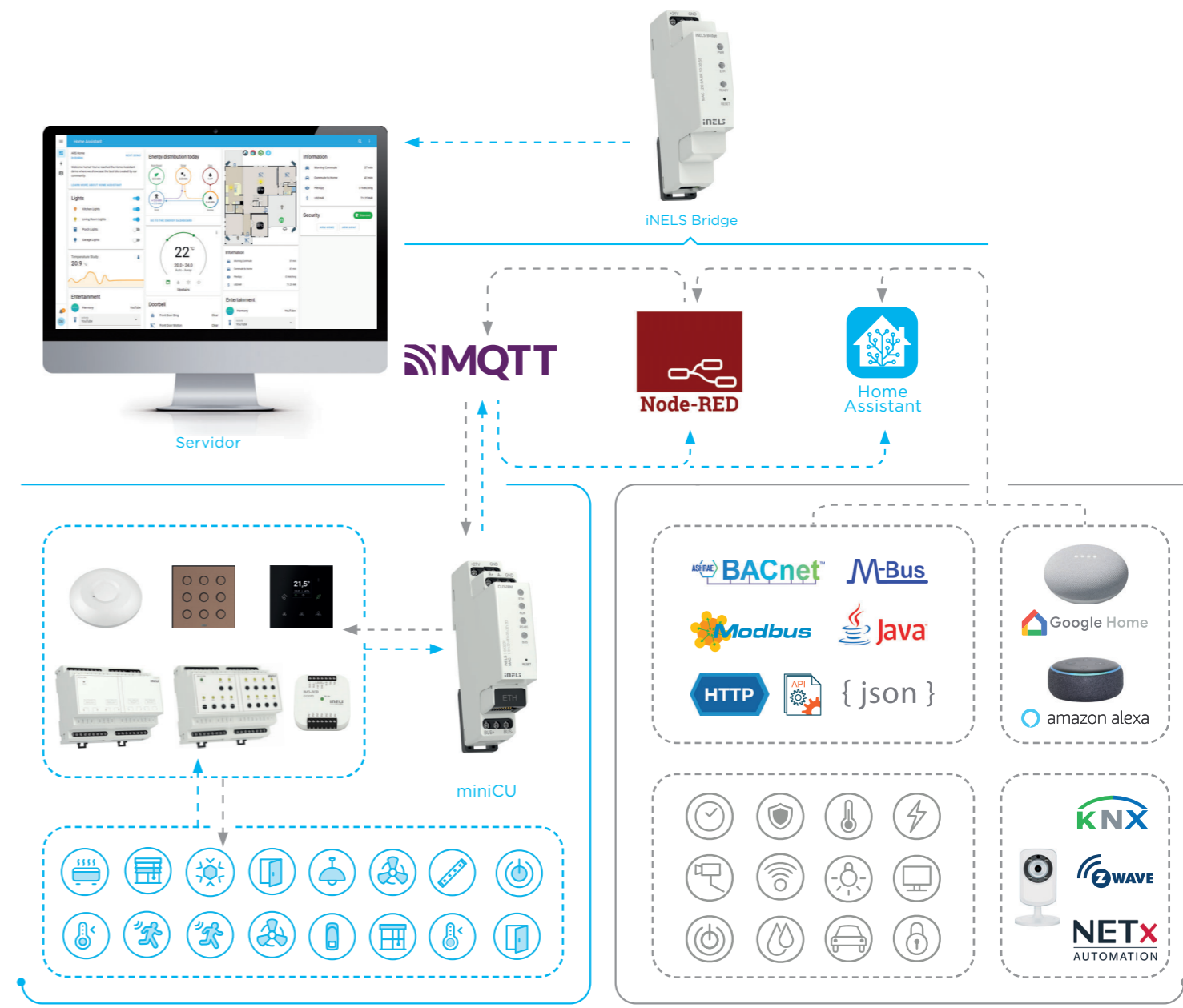

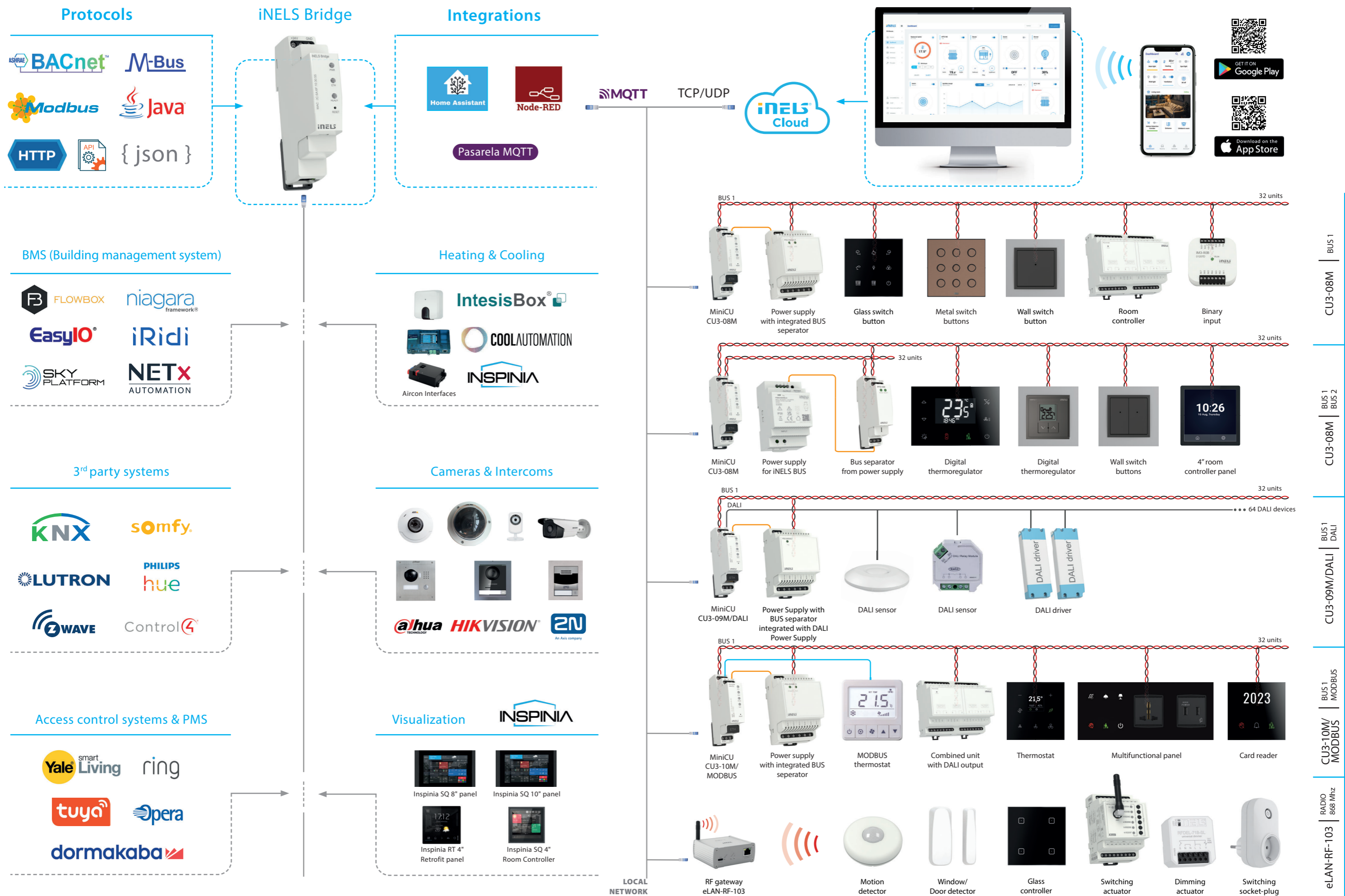

Central units



CU3-08M
Central unit with 2x BUS, max. 64 Elements



CU3-09M/DALI
Central unit with 1 BUS, 1x DALI, max. 32 Elements



CU3-10M/MODBUS
Central unit with 1x BUS, 1x MODBUS



iNELS Bridge
Third-party integration gateway

Detectors | sensors



MCD3-01
Ultra slim microwave motion detector - ceiling mount



PMS3-01
Ultra slim PIR motion detector - ceiling mount



DLS3-1
Light intensity sensor

Converters



ADC3-60M
Analog-to-digital converter, 6 inputs



DAC3-04M
Digital to analog converter, 4 outputs

Input units



IM3-40B
Binary input unit, 4 inputs



IM3-80B
Binary input unit, 8 inputs



IM3-140M
Binary input unit, 14 inputs



TI3-40B
Temperature input, 4 inputs



TI3-60M
Temperature input, 6 inputs

Switching actuators



SA3-01B, SA3-02B
Switching actuator, 1 channel and 2 channels



SA3-04M
Switching actuator, 4 channels



SA3-06M
Switching actuator, 6 channels



SA3-014M
Switching actuator, 14 channels



SA3-014M/E
Switching actuator, 14 channels (without manual control buttons and indicators)



SA3-022M
Switching actuator, 22 channels



EA3-022M
Switching actuator without controls and indicators, 22 channels

System units



PS3-30/iNELS
Power supply with integrated BUS separator



PS3-30/DALI
Power Supply with BUS separator integrated with DALI Power Supply



BPS3-01M, BPS3-02M
Bus separator from power supply



PSM3-30/iNELS
Power supply for iNELS BUS



PSM3-60/iNELS
Power supply for iNELS BUS



PSM3-100/iNELS
Power supply for iNELS BUS

Converters



IBWL3-xxB-SL
iNELS BUS wireless link

Lighting control



DA3-22M
Universal dimming actuator, 2 channels



DA3-66M
Dimming actuator, 6 channels



DA3-03M/RGBW
Dimming actuator for RGBW strips

Shutter actuators



JA3-014M
Shutter actuator, 14 channels



JA3-014M/E
Shutter actuator, 14 channels (without manual control buttons and RE status LED)

Combined units



RC3-610M/DALI
Room controller with DALI dimmer



FA3-612M
Fancoil controller

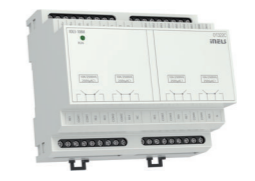

IOU3-108M
Universal unit with 10 inputs and 8 outputs

Legend:



NEW

Wall controllers

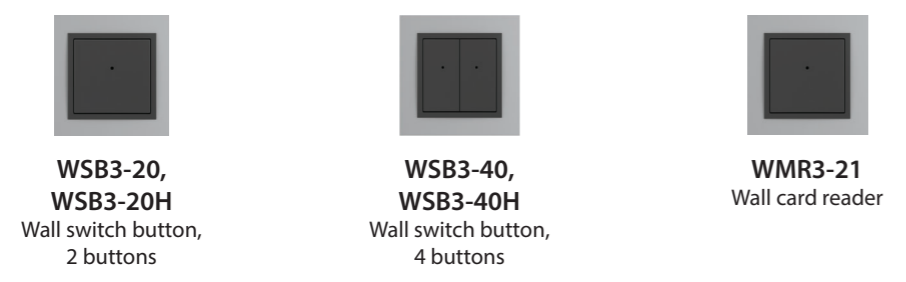

Glass controllers



Metal controllers



Metal switch buttons

Thermo-regulators



Touch units



Multimedia

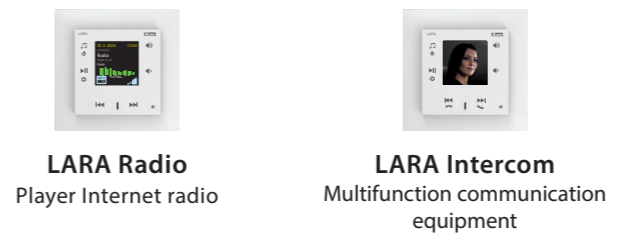

iNELS app



Accessories





EAN code
CU3-08M: 8595188191630
Order Code: 9163

Technical parameters CU3-08M

Indication LED STATUS

Green - RUN:	The main program runs
Red - ERR:	The main program stalled

Communication

System bus BUS1/BUS2	
Status indication (LED BUS):	green - indication of the operating status of the bus red - error indication on the bus
Maximum number of units:	2x32 Units
Maximum line length:	max. 300 m (depends on power loss)
Ethernet	
Connector:	RJ45
Communication speed:	100 Mbps
Ethernet status indication (LED ETH):	green - Ethernet communication yellow - Ethernet speed 100 Mbps
Default IP address:	192.168.1.1

RESET button

Restart:	Short press
Reset (factory reset settings):	press the button to bring power on, button release 10 s after power is supplied

Power

From bus BUS2	
Supply voltage/tolerance:	27 V DC, -20/+10 %
Rated current:	50 mA (at 27 V DC)

Operating conditions

Working temperature:	-20 to +55 °C
Storage temperature:	-25 to +70 °C
Air humidity:	max. 80%
Degree of protection:	IP20 device, IP40 with cover in the control cabinet
Degree of pollution:	2
Working position:	any
Installation:	to the control cabinet for DIN rail EN 60715
Design:	1-MODULE
Terminal plate:	max. 2.5 mm ²

Dimensions and weight

Dimensions:	94 x 17.6 x 64 mm
Weight:	72 g
Standards:	EN 63044-1, EN 62368-1

- CU3-08M is one of the basic system control of iNELS BUS installations.
- The unit can work independently, as an autonomous project, or it can be controlled by the central software as part of a larger Project.
- The units is equipped with two BUS, to which it is possible to connect a total of up to 64 elements (2x32) from the iNELS BUS portfolio.
- The current load of one line is max. 1 A. BPS3-01M with 3 A can be used incase of connected device with more than 1 A.
- The RJ45 100 Mbps Ethernet connector is used for direct communication with the cloud for mobile app control or for communication with the superior unit within the iNELS IP topology.
- Configuration takes place in the iNELS3 Designer & Manager software (iDM3). Through iDM3 it is possible to update the firmware of central units and bus connected peripheral units.
- The central unit is implemented with MQTT protocol for 3rd party communication.
- The unit is powered from the BUS2 bus. Through the iNELS power supply and the BPS3 bus isolator.
- System units CU3-08M in 1-MODULE design are designed for mounting into a switchboard on DIN rail EN60715.

Connection

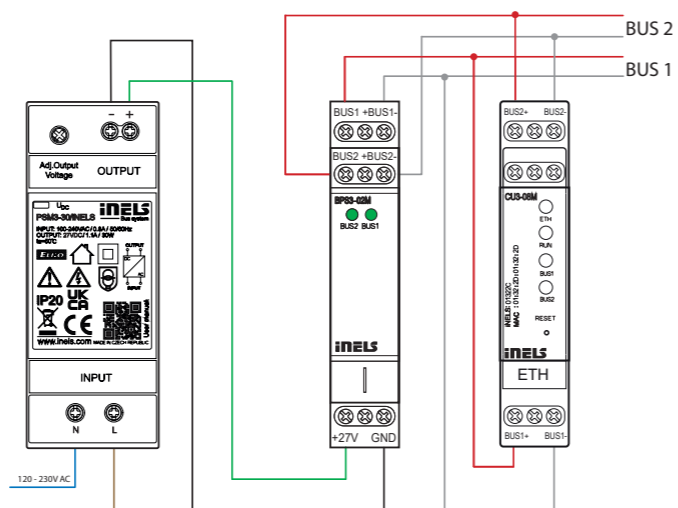

EAN code
CU3-09M/DALI: 8595188184656
Order Code: 8465

Technical parameters CU3-09M/DALI

Indication LED STATUS

Green - RUN:	The main program runs
Red - ERR:	The main program stalled

Communication

System BUS	
Maximum number of units:	max. 32 Units
Status indication (LED BUS):	green: BUS Operating Status red: error indication on the bus

Output interface DALI

DALI addresses max.	64
Bus power supply:	external DALI power supply must be connected
Status indication (LED DALI):	green: DALI Operating Status

Ethernet

Connector:	RJ45
Communication speed:	100 Mbps
Ethernet status indication (LED ETH):	green - Ethernet communication yellow - speed Ethernet 100 Mbps
Default IP address:	192.168.1.1

RESET button

Restart:	short press
Reset (return to factory settings):	press the button to bring power on, button release 10 s after power is supplied

Power

Supply voltage/tolerance:	27 V DC, -20/+10 %
Rated current:	50 mA (at 27 V DC)

Operating conditions

Working temperature:	-20 to +55 °C
Storage temperature:	-25 to +70 °C
Air humidity:	max. 80%
Degree of protection:	IP20 device, IP40 with cover in the control cabinet
Degree of pollution:	2
Working position:	any
Installation:	to the control cabinet for DIN rail EN 60715
Design:	1-MODULE
Terminal plate:	max. 2.5 mm ²

Dimensions and weight

Dimensions:	94 x 17.6 x 64 mm
Weight:	72 g
Standards:	EN 63044-1, EN 62368-1

- CU3-09M is one of the basic system control units of iNELS BUS installations.
- The unit can work independently, as an autonomous project, or it can be controlled by the central software as part of a larger project.
- The unit is equipped with one BUS to which it is possible to connect up to 32 elements from the iNELS BUS portfolio.
- The current load of one line is max. 1 A. BPS3-01M with 3 A can be used incase of connected device with more than 1 A.
- The CU3-09M/DALI system unit is equipped with one DALI bus.
- The DALI system bus allow control of up to 64 independent DALI devices.
- Addressing of DALI can be done via the iDM3 software.
- The RJ45 100 Mbps Ethernet connector is used direct communication with the cloud for mobile app control or for communication with the superior unit within the iNELS IP topology.
- Configuration takes place in the iNELS3 Designer & Manager software (iDM3).
- Through iDM3 it is possible to update the firmware of central units and bus connected peripheral units.
- The central unit is implemented with MQTT protocol for 3rd party communication.
- The unit is powered by 27 V DC from iNELS power supply.
- System units CU3-09M/DALI in 1-MODULE design are designed for mounting into a switchboard on DIN rail EN60715.

Connection

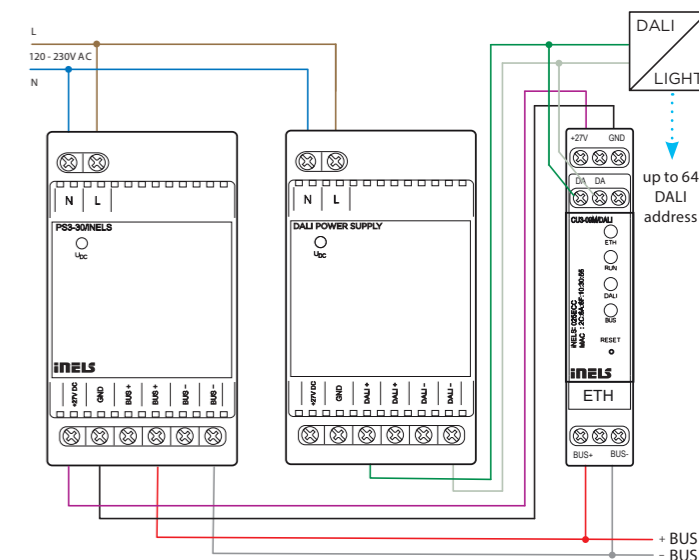



EAN code
CU3-10M/MODBUS: 8595188185219
Order Code: 8521

Technical parameters CU3-10M/MODBUS

Indication LED STATUS	
Green - RUN:	Flashing-communication with BUS, On-no communication
Red- ERR:	Flashing - no project, ON - unit STOP
Communication	
System bus BUS1	
Status indication (LED BUS):	green - unit status indication red - BUS fault indication
Maximum number of units:	max. 32 units to one BUS line
Maximum line length:	max. 300 m (depends on power loss)
Ethernet	
Connector:	RJ45
Communication speed:	100 Mbps
Ethernet status indication (LED ETH):	green - Ethernet communication yellow - Ethernet speed 100 Mbps
Default IP address:	192.168.1.1
RESET button	
Restart:	short press
Reset (factory reset settings):	press the button to apply power, release the button 10 s after power is applied
Power	
BUS	
Supply voltage/tolerance:	27 V DC, -20/+10 %
Rated current:	50 mA (at 27 V DC)
Operating conditions	
Working temperature:	-20 to +55 °C
Storage temperature:	-25 to +70 °C
Air humidity:	max. 80%
Degree of protection:	IP20 device, IP40 with cover in the switchboard
Surge category:	II.
Degree of pollution:	2
Working position:	any
Installation:	to the switching board on the EN 60715 DIN rail
Design:	1-MODULE
Terminal plate:	max. 2.5 mm ²
Dimensions and weight	
Dimensions:	94 x 17.6 x 64 mm
Weight:	72 g
Standards:	EN 63044-1, EN 62368-1

- CU3-10M/MODBUS is one of the basic system control units of iNELS BUS installations.
- The unit can work independently, as an autonomous project, or it can be controlled by the central software as part of a larger project.
- The unit is equipped with one BUS to which it is possible to connect up to 32 elements from the iNELS BUS portfolio.
- The current load of one line is max. 1 A. BPS3-01M with 3 A can be used in case of connected device with more than 1 A.
- The CU3-10M/MODBUS system unit is equipped with one Modbus system bus. The Modbus system bus allows control of modbus thermostat and Air condition units (RS-485).
- The RJ45 100 Mbps Ethernet connector is used for direct communication with the cloud for mobile app control or for communication with the superior unit within the iNELS IP topology.
- Configuration takes place in the iNELS3 Designer & Manager software (iDM3). Through iDM3 it is possible to update the firmware of central units and bus connected peripheral units.
- The central unit is implemented with MQTT protocol for 3rd party communication.
- The unit is powered by 27 V DC from iNELS power supply.
- System units CU3-10M/MODBUS in 1-MODULE design are designed for mounting into a switchboard on DIN rail EN60715.

Connection

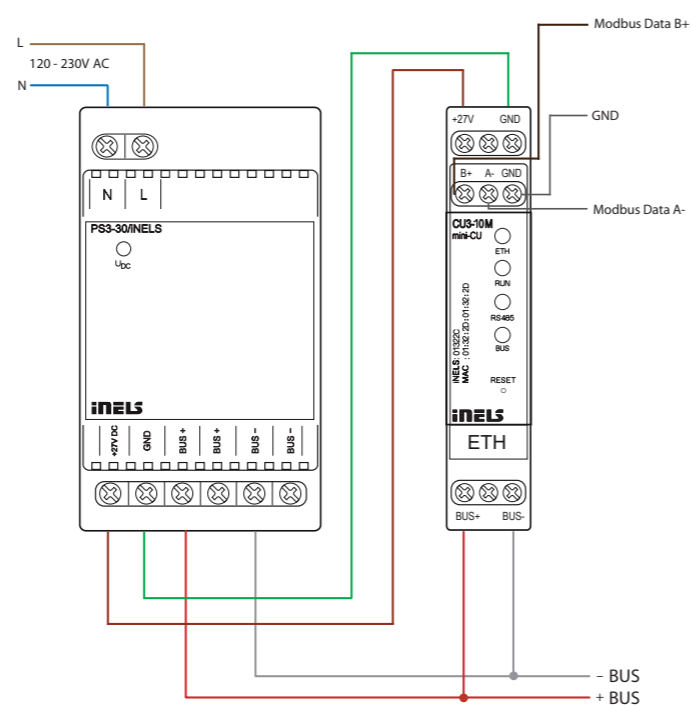

EAN code
iNELS Bridge 24V DC: 8595188185097
Order Code: 8509

Technical parameters iNELS Bridge

Communication	
Communication network:	Ethernet
Pre Installed software:	Home Assistant, MQTT Broker
Ethernet	
Connectors:	RJ-45
Communication speed:	10/100Mb
Ethernet status indication:	LED link
Preset IP address (ETH):	DHCP, mDNS
Power supply	
Version 24V DC:	8-36 V DC/1 A
Operating conditions	
Operating temperature:	-20 to +55 °C
Storage temperature:	-25 to +70 °C
Humidity:	max. 80%
Degree of protection:	IP20
Overvoltage category:	II.
Degree of pollution:	2
Operating position:	any
Installation:	DIN rail EN 60715
Design:	1-MODULE
Terminal:	max. 2.5 mm ²
Dimensions and weight	
Dimensions:	94 x 17.6 x 64mm
Weight:	72 g
Standard:	EN 63044-1, EN 62368-1

- iNELS Bridge works as a gateway for connecting third party devices and integrating them into the iNELS environment.
- It is a one module hardware containing a powerful Linux-based computer.
- The unit comes with an option of pre-installed Home Assistant with iNELS driver.
- The server uses the open Home Assistant platform, which contains more than 1000 existing integrations.
- The connection server is providing a communication environment between iNELS BUS System with the third-party devices, for which their protocols are also translated and submitted.
- iNELS Bridge is equipped with an Ethernet port for fast and easy communication.
- The configuration is happening on its own web interface, where the default IP address is not fixed. (The IP address is assigned from the DHCP server and it's needed to be known when we're connected to the network).
- The device can be powered by 24VDC input, and it also supports Power over Ethernet (Passive POE), providing flexibility in power options.

Device description

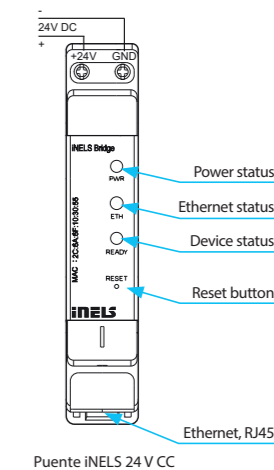

Puente iNELS 24 V CC

Integrations and protocols

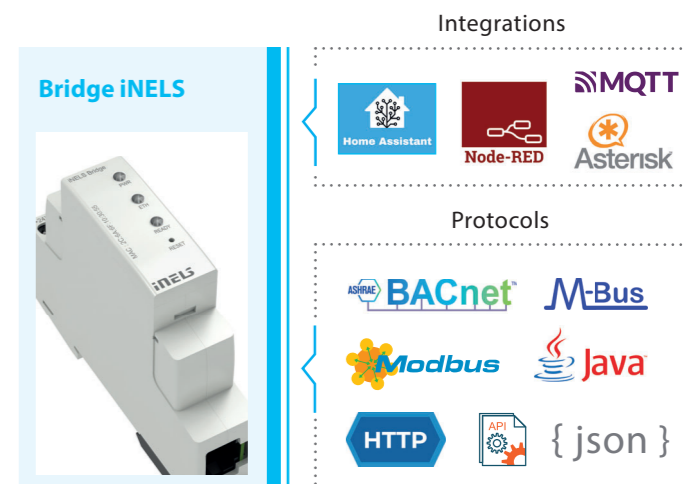



EAN code
PS3-30/iNELS: 8595188180115
Order Code: 8011

Technical parameters PS3-30/iNELS

Input AC	
Supply voltage:	100 - 250 V AC/50 - 60 Hz
Power dissipation:	max. 6.5 W
No-load power (apparent/active):	max. 10 VA/1.5 W
Power consumption at max. Load (apparent/active):	max. 54 VA/33 W
Protection:	T2A fuse inside the device
Outputs	
Output voltage:	27 V
Max. load capacity:	1 A
Overall resource efficiency:	> 82 %
Time delay after Connection to AC network:	max. 5 s
Indication LED	
Green LED U _{DC} :	output voltage indication
Operating conditions	
Electrical power INPUT AC - OUTPUT BUS:	4 kV
Connection terminals:	Ordinal
Cross-section of connecting wires (mm ²):	max. 1 x 2.5, max. 2 x 1.5 (With core max. 1 x 1.5)
Working temperature:	-20 °C to +55 °C
Storage temperature:	-30 °C to +70 °C
Working air humidity:	20 to 90 % RH
Degree of protection:	IP20 device, IP40 with cover in the control cabinet
Surge category:	III.
Degree of pollution:	2
Working position:	any, optimally vertical
Installation:	to the control cabinet for DIN rail EN 60715
Design:	3-MODULE
Dimensions:	90 x 52 x 65 mm
Weight:	160 g
Related standards:	general: EN61204, safety: EN61204-7, EMC: EN61204-3

- PS3-30/iNELS is a switched stabilized power supply with a total power of 30 W.
- PS3-30/iNELS is used to power central units and external masters within the iNELS bus wiring.
- PS3-30/iNELS it is equipped with electronic protection against short circuit, overvoltage, power and temperature overload.
- The power supply includes an internally integrated BPS3-01M bus isolator to power one branch of the BUS, from which the iNELS peripheral units are further powered.
- PS3-30/iNELS 3-MODULE is designed for mounting in a switchboard on DIN rail EN60715.

Connection

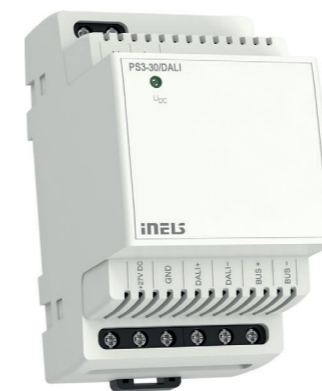
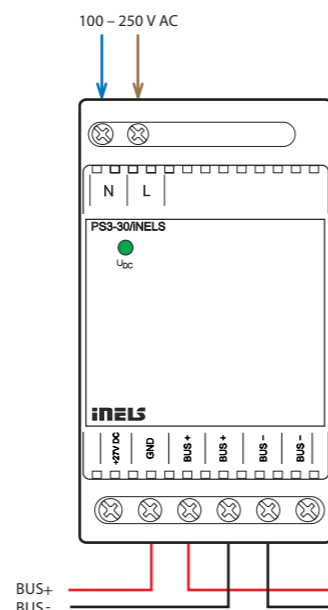

EAN code
PS3-30/DALI: 8595188192606
Order Code: 9260

Technical parameters PS3-30/DALI

Input AC	
Supply voltage:	100 - 250 V AC/50 - 60 Hz
Power dissipation:	max. 6.5 W
No-load power (apparent/active):	max. 10 VA/1.5 W
Power consumption at max. Load (apparent/active):	max. 54 VA/33 W
Protection:	T2A fuse inside the device
Outputs	
27 V	
Output voltage:	27 V
Max. load capacity:	1 A
BUS	
Output voltage:	27 V
Max. load capacity:	1 A
DALI	
Output voltage:	16 V
Max. load capacity:	250 mA
Max. total load capacity*	30 W
Overall resource efficiency:	> 82 %
Time delay after Connection to AC network:	max. 5 s
Indication LED	
Green LED U _{DC} :	output voltage indication
Operating conditions	
Electrical power INPUT AC - OUTPUT BUS:	4 kV
Connection terminals:	Ordinal
Cross-section of connecting wires (mm ²):	max. 1 x 2.5, max. 2 x 1.5 (With core max. 1 x 1.5)
Working temperature:	-20 °C to +55 °C
Storage temperature:	-30 °C to +70 °C
Working air humidity:	20 to 90 % RH
Degree of protection:	IP20 device, IP40 with cover in the control cabinet
Surge category:	III.
Degree of pollution:	2
Working position:	any, optimally vertical
Installation:	to the control cabinet for DIN rail EN 60715
Design:	3-MODULE
Dimensions:	90 x 52 x 65 mm
Weight:	174 g
Related standards:	general: EN61204, safety: EN61204-7, EMC: EN61204-3

* The maximum total load capacity is the sum of the loads of the individual outputs. (iNELS BUS + DALI BUS)

- PS3-30/DALI provides 30 W total power for both iNELS bus (27 V DC) and DALI devices (16 V DC), ensuring efficient power distribution for central units, external masters, and peripheral devices including DALI BUS.
- PS3-30/DALI includes an internally integrated bus isolator to power one branch of the iNELS BUS, maintaining reliable and isolated power supply for connected peripheral units.
- Equipped with electronic protection against short circuits, overvoltage, power overload, and temperature overload, ensuring safe and stable operation.
- Offers over 85% efficiency, optimizing energy consumption and reducing heat generation.
- Compact Design: 3-module unit designed for easy mounting on DIN rail EN60715, allowing for streamlined installation in switchboards and control panels.
- Supports a wide input voltage range of 100-240 V AC and operates in temperatures from -20°C to +55°C, suitable for various environmental conditions.
- Meets safety standards EN 60950-1 and EN 62368-1, EMC standards EN 55032 and EN 55024, and is RoHS compliant, ensuring adherence to international safety and environmental regulations.

Connection

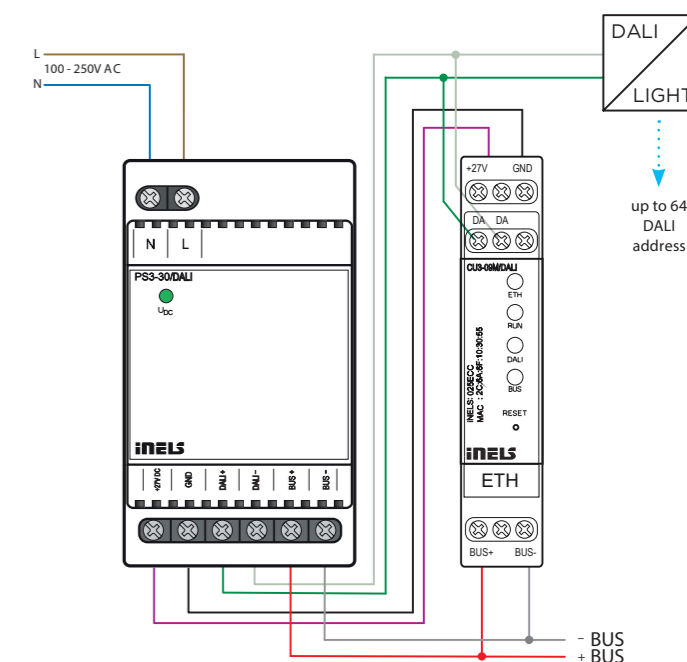



EAN code
BPS3-01M: 8595188132442
BPS3-02M: 8595188132435

Order Code:
BPS3-01M: 9164
BPS3-02M: 9165

Technical parameters

	BPS3-01M	BPS3-02M
Outputs		
Maximum load capacity:	3 A	2x 1 A
Communication		
Installation bus:	1x BUS	2x BUS
Power		
Supply voltage/tolerance:	27 V DC, -20/+10 %	
Power dissipation:	max. 0.5 W	
Rated current without		
Output load:	max. 8 mA	max. 15 mA
Voltage status indication on		
Terminals:	1x green LED	2x green LED
Connection		
Terminal plate:	max. 2.5 mm ² /1.5 mm ² with core	
Operating conditions		
Working temperature:	-20 to +55 °C	
Storage temperature:	-30 to +70 °C	
Cover:	IP20 device, IP40 with cover in the control cabinet	
Surge category:	II.	
Degree of pollution:	2	
Working position:	any	
Installation:	to the control cabinet for DIN rail EN 60715	
Design:	1-MODULE	
Dimensions and weight		
Dimensions:	90 x 17.6 x 64 mm	
Weight:	70 g	85 g
Standards:	EN 63044-1	

- The BPS3-01M and BPS3-02M units are used for impedance separation of the BUS from the supply voltage source.
- A BPS3-01M or BPS3-02M bus isolator is required for each CU3-XXM central unit.
- BPS3-01M allows the connection of one BUS branch with a load of max. 3 A.
- BPS3-02M allows the connection of two BUS branches with a load of max. 1 A for each branch.
- The outputs are equipped with overcurrent and surge protection.
- Indication of the output voltage of the BUS outputs by LEDs.
- BPS3-01M, BPS3-02M in 1-MODULE design are designed for mounting in a switchboard on DIN rail EN60715.

Connection

BPS3-02M + CU3-08M

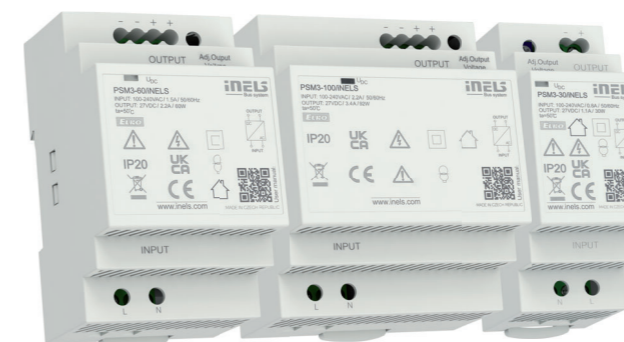
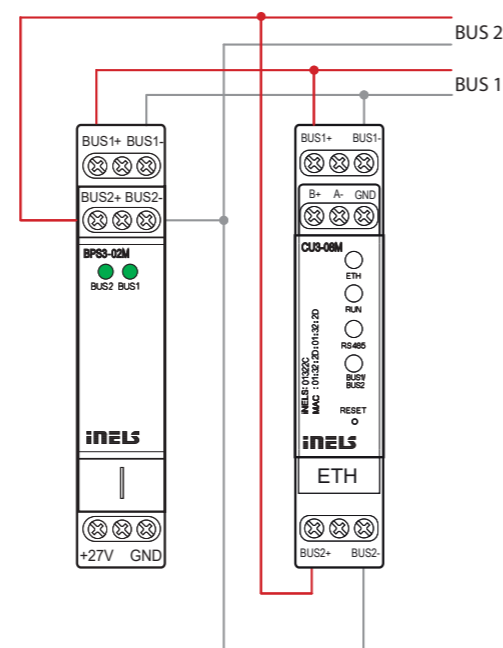

EAN code: PSM3-100/iNELS - 8595188184786
PSM3-60/iNELS - 8595188184779
PSM3-30/iNELS - 8595188184762

Order Code: PSM3-100/iNELS - 8478
PSM3-60/iNELS - 8477
PSM3-30/iNELS - 8476

- Used to supply central units and external master within intelligent electroinstallation iNELS.
- Through BUS separators from the supply voltage BPS3-01M and BPS3-02M, it supplies BUS lines from which iNELS peripheral units are also powered.
- Rated output voltage 27V DC with the possibility of regulation.
- High efficiency of up to 90%.
- Low ripple & noise.
- Protection: Overload, Over voltage and Short circuit.
- Continuously adjustable output voltage to adapt to the specific application, e.g. the need to compensate for the voltage drop caused by the length of the line.

Technical parameters	PSM3-30/iNELS	PSM3-60/iNELS	PSM3-100/iNELS
Input			
Voltage range:	AC 100 - 240 V (50-60 Hz)		
Tolerance:	± 10%		
Efficiency:	89%	90%	90%
Burden without load (max.):	0.4W / 8VA	0.5W / 6.5VA	0.1W / 12VA
Burden with full load (max.):	33W / 60VA	70W / 111VA	105W / 160VA
Inrush current:*	max. 25A at 115V AC/60Hz max. 45A at 240V AC/50Hz	max. 30A at 115V AC/60Hz max. 60A at 240V AC/50Hz	max. 35A at 115V AC/60Hz max. 70A at 240V AC/50Hz
Output			
Rated voltage:	27V DC	27V DC	27V DC
Vol. setting range:	21.5 - 28.5V	20.5 - 29V	24.5 - 28V
Rated current:	1.1A	2.2A	3.4A
Rated power:	30W	60W	92W
Ripple & Noise:	150mV	150mV	150mV
Output indication:	blue LED	green LED	blue LED
Tolerance of output voltage:	5 %		
Overload protection:	from 130% - 200% rated output power		
Overvoltage protection:	from 110 % - 145% rated output power		
Overcurrent protection:	from 110% - 180% rated output power		
Short circuit protection:	temporarily disconnecting the output		
Other information			
Operating temperature:	-20 to +50°C		
Operating humidity:	20% ~ 90% non-condensing		
Storage temperature:	-40 to +80°C		
Dielectric strength:	3kV AC		
Isolation resistance:	100M Ω / 500V DC / 25°C / 70% RH		
Overvoltage category:	III.		
Pollution degree:	2		
Max. cable size:	max. 1x 2.5 mm ² , max. 2x 1.5 mm ² solid wire / with sleeve max. 1x 2,5 mm ²		
Terminal torque:	0.3 Nm		
Input terminals:	0.3 Nm		
Output terminals:	0.5 Nm		
Protection degree:	IP20		
MTBF:	200 000 hours minimum, full load at 25°C ambient temperature		
Mounting:	DIN rail EN 60715		
Dimensions:	90 x 35 x 58 mm	90 x 52.5 x 58 mm	90 x 70 x 58 mm
Weight:	120 g	190 g	270 g
Standards:	general: EN61204, safety: EN61204-7, EMC: EN61204-3		

* The stated values are valid for the full load from the source

Description

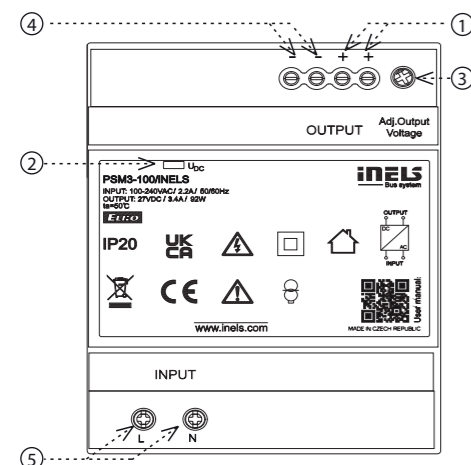
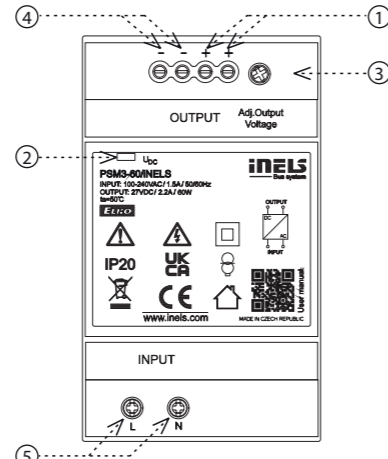
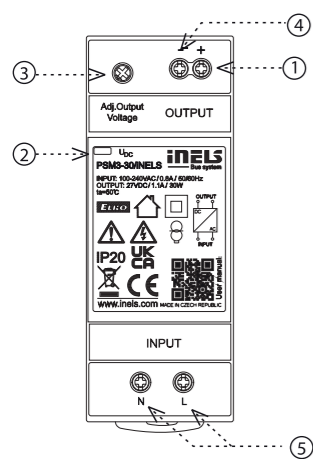

1. Output voltage terminals ⊕
2. Output voltage indication
3. Adjusting the output voltage
4. Output voltage terminals ⊖
5. Supply terminals

Connection

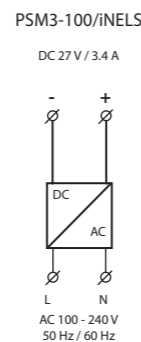
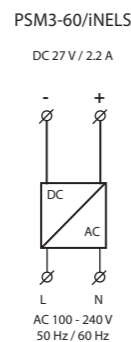
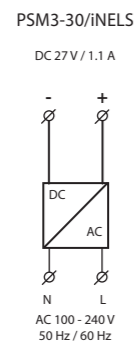

Power supplies PSxM are overcurrent protection devices, because it turns power supplies off, if the output current exceeds more than 30 % of the rated output of the power supply. Therefore, these units are not intended to supply e.g. halogen lamps, because the starting / inrush current (in the cold state) is approximately ten times the amount of the steady-state operating current. So these power supplies cannot turn on such lamps.



EAN code
MCD3-01: 8595188191234
Order Code: 9123

Technical parameters		MCD3-01
Inputs		
HF system:	5.8 GHz CW radar, ISM band	
Detection angle:	360°	
Reach:	2-10 m (radius.), adjustable	
Time setting:	in iDM software	
Recommended installation height:	2.5 - 3 m	
Changing the sensitivity:	yes (in hardware)	
Light metering:	yes (in hardware)	
Communication		
Terminals:	0.3 - 0.8 mm ²	
Interface:	installation iNELS BUS	
Power supply		
From iNELS BUS:	27 V DC, -20/+10 %, 20 mA	
Operating conditions		
Work temperature:	-10 to 40 °C	
Operation position:	free	
Installation:	ceiling/surface	
Dimension and weight		
Dimension:	115 x 24 mm	
Standards:	EN 302372, EN 301489, EN 63044-1	

Connection

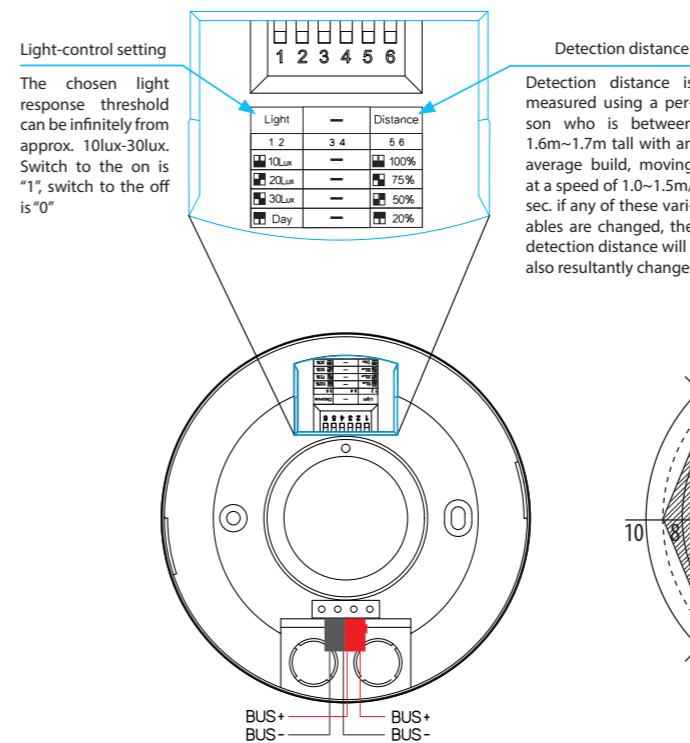

Another view

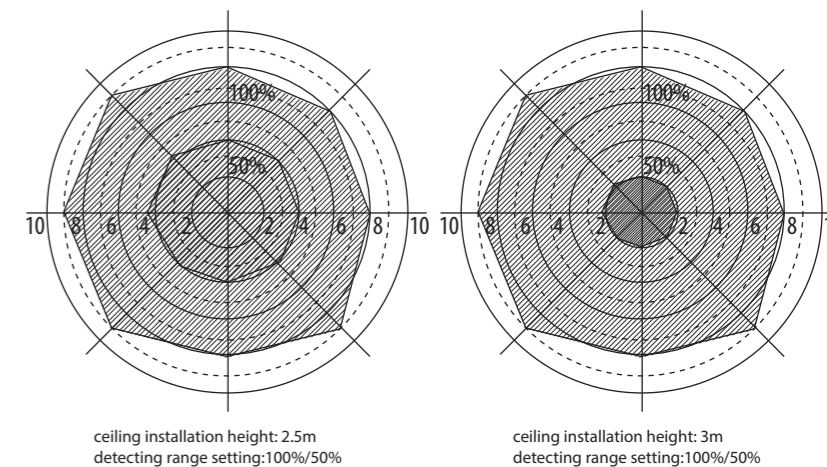
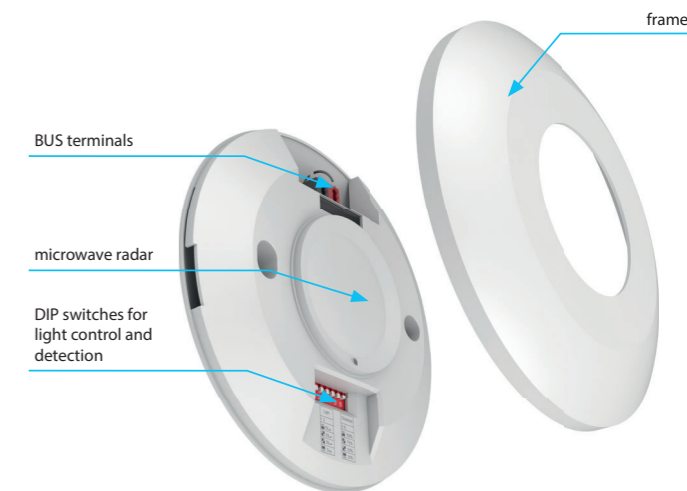



EAN code
PMS3-01: 8595188191357
Order Code: 9135

Technical parameters		PMS3-01
Function		
Detection angle:	360°	
Time setting:	in iDM software	
Recommended installation height:	2.5 - 3.5 m	
Communication		
Terminals:	EIB ϕ 0.3 - 0.8 mm ²	
Interface:	installation iNELS BUS	
Power supply		
From iNELS BUS:	27 V DC, -20/+10 %, 20 mA	
Operating conditions		
Work temperature:	-10 to 40 °C	
Operation position:	free	
Installation:	ceiling/surface	
Dimension and weight		
Dimension:	115 x 24 mm	
Standards:	EN 63044-1	

Connection

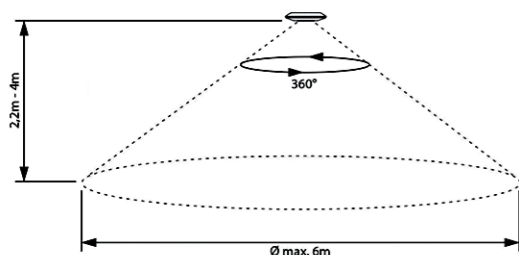
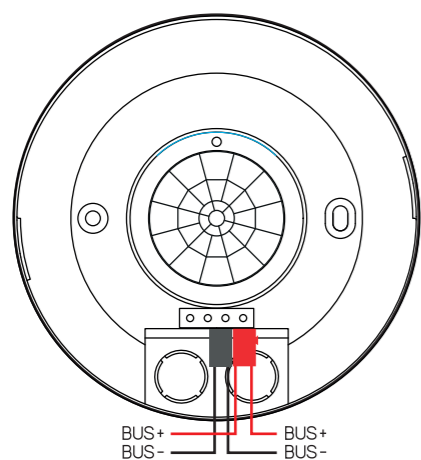

- The PMS3-01 is a highly versatile and compact motion sensor designed for ceiling or surface mounting applications. With its ultra-slim design, the PMS3-01 seamlessly integrates into various environments, providing reliable and efficient motion detection capabilities.
- The sensor is powered by a 27 VDC power source, specifically the iNELS BUS system, ensuring stable and efficient operation.
- The PMS3-01 utilizes an infrared for precise and reliable motion detection.
- The sensor provides a wide 360-degree detection angle, ensuring comprehensive coverage of the monitored area.
- The sensor's reach is up to 6m max, allowing the user to install the unit at a height of 2.5 m-3.5 m, providing flexibility for different applications.
- The PMS3-01 features a software setting for adjusting time settings. The time setting can be configured, allowing customization of the sensor's activation duration.
- Designed to operate effectively in various environmental conditions, the sensor has a wide working temperature range of -10°C to +40°C, ensuring reliable performance in different settings.
- The PMS3-01 can be seamlessly integrated and combined with other iNELS units using the iDM3 software. This allows for the implementation of additional logics and functions, enabling automation and customized control scenarios based on specific requirements.
- The PMS3-01 features a compact form factor with dimensions of 115 x 24 mm, facilitating easy installation and integration into different ceiling or surface mounting applications.

Another view

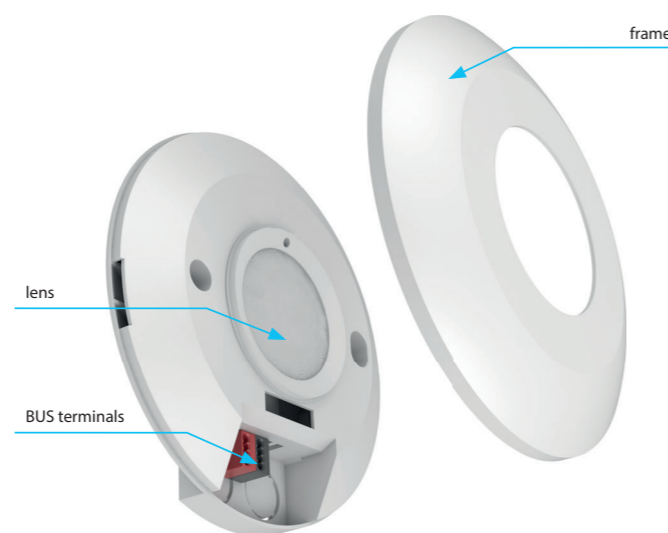

EAN code
DLS3-1: 8595188157506
Order Code: 5750

Technical parameters		DLS3-1
Inputs		
Range of measurement of lighting:	1 - 100 000 lx	
Detection angle:	40°	
Outputs		
Indication red LED:	identification DALI MASTER/setting indication	
Indication green LED RUN:	communications/unit status	
Communication		
Interface:	installation iNELS BUS, DALI	
Power supply		
From iNELS BUS:	27 V DC, -20/+10 %	
Rated current:	12 mA (27 V DC)	
From DALI BUS:	16 V (max. 23 V)	
Rated current:	20 mA (16 V DC)	
Dissipated power:	max. 0.5 W	
Connection		
Terminals:	max. 1x2.5, max. 2x1.5/with sleeve max. 1x2.5 mm ²	
Operating conditions		
Operating temperature:	-30 to +60 °C	
Storing temperature:	-30 to +70 °C	
Protection degree:	IP65	
Operating position:	vertical	
Dimension and weight		
Dimension:	96 x 62 x 34 mm	
Weight:	100 g	
Standards:	EN 63044-1	

For proper function of the detector it is necessary to eliminate all sources of light interference in the sensing area.

- The luminescence sensor DLS3-1 is for sensing the current luminescence at the point of installation of the unit.
- The DLS3-1 sensor is equipped with two communication interfaces:
 - iNELS BUS installation
 - DALI (a maximum 4 pcs of DMD3-1 or DLS3-1 units can be used on one DALI bus).
- Information about the current value of the light intensity can be used in tasks of maintaining constant luminescence. In space where it is possible, thanks to the contribution of natural light from the outside to adjust the artificial light, which can reduce energy consumption.
- Thanks to the DLS3-1 units cannot only be used in residential projects, but also in commercial projects, offices or manufacturing plants, warehouses.
- The DLS3-1 unit is recommended to be installed so that the luminescence sensor for sensing faces down and should not be exposed to direct radiation.
- Setting up a communication interface with DIP switches no. 1:
 - in the upper position determines the communication interface DALI
 - in the lower position determines the communication interface iNELS.
- The DLS3-1 detector is powered directly via the iNELS BUS installation (nominal 27 V DC) or DALI BUS (nominal 16 V DC).
- The unit can be configured via iNELS3 Designer & Manager software, which, amongst other things it is possible to:
 - Set the desired functions according to the detected illumination.
- The sensing range is 1-100 000 lux.
- The DLS3-1 unit is supplied in IP65 and so can be installed in the outdoor environment.

Connection

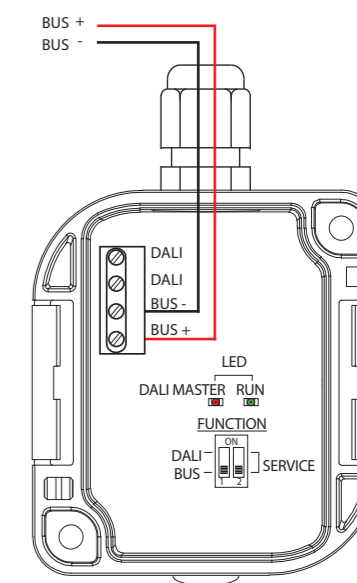

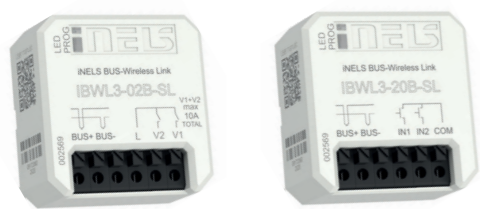

EAN code:
IBWL3-02-SL: 8595188193689
IBWL3-20-SL: 8595188193993

Technical parameters	IBWL3-02B-SL	IBWL3-20B-SL
Inputs		
Input:	-	2xswitching or expanding against GND (-)
Max. pulse reading frequency:	-	20 Hz
Output		
Number of contacts:	2xswitching	-
Rated current:	8 A / AC1	-
Switching power:	2000 VA / AC1	-
Peak current:	I _{peak} < 110A 300us / max. input capacity 125 uF	-
Switching voltage:	250 V AC1	-
Mechanical service life:	1x10 ⁷	-
Electrical service life (AC1):	1x10 ⁵	-
Communications		
RF		
Wireless:	max. 8 addresses can be assigned	
Communication Protocol:	RFIO2	
Frequency:	866–922 MHz (viz str. 81)	
Range:	in open space up to 200 m	
BUS		
Installation bus	BUS	
Unit status indication	green LED RUN	
Power supply		
Supply voltage tolerance:	27 V DC, -20/+10 %	
Power dissipation:	max. 1 W	
Rated current:	25 mA (at 27 V DC), from bus the BUS	
Connecting		
Terminal block:	screwless terminals	
Connection wire cross section (mm ²):	0.2-1.5 solid/flexible	
Other data		
Humidity:	max. 80 %	
Operating temperature:	-20 .. +55 °C	
Storage temperature:	-30 .. +70 °C	
Protection:	IP40	
Overvoltage Category:	II.	
Contamination degree:	2	
Operating position:	any	
Installation:	free at lead-in wires	
Design:	box SL	
Dimensions and weight		
Dimensions:	43 x 44 x 22 mm	
Weight:	45 g	45 g
Related standards:	EN 63044-1	

- The IBWL3-xx module enables seamless integration of iNELS wireless devices (such as controllers and detectors) with the wired iNELS BUS system, enhancing control and flexibility.
- The IBWL3-XX expands system capabilities by enabling wireless devices to trigger events and interact with other BUS elements, making it ideal for smart home and building automation.
- Two options available:
 - IBWL3-02B-SL:** Supports up to 8 wireless devices and includes 2 built-in relays for direct control of wired components.
 - IBWL3-20B-SL:** Supports up to 8 wireless devices and features 2 dry contact inputs for external devices.
- Wireless devices are paired using unique RF addresses through the iNELS Design Manager (iDM3), allowing the control unit (CU3-XX) to recognize and create logic with BUS system elements.
- Each IBWL3 module can connect up to 8 wireless devices.
- The module is housed in a compact box design and powered directly by the 27V iNELS BUS, ensuring simple installation and a sleek, unified look.

Device description

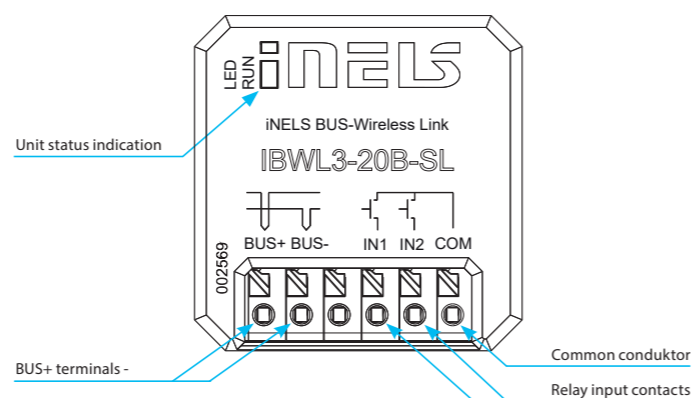
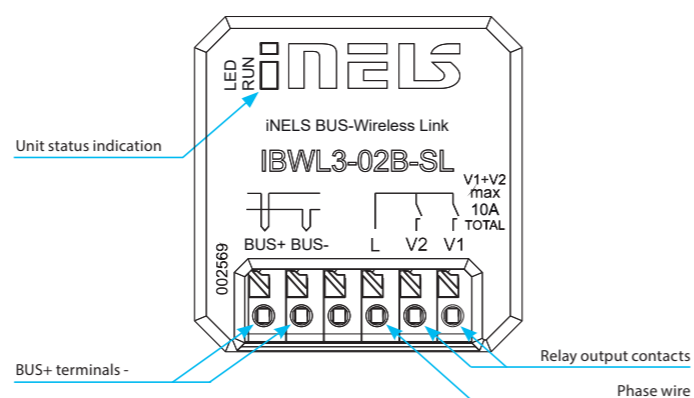

Connection

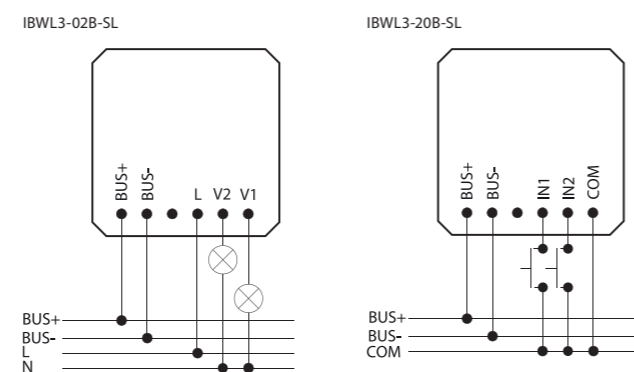

EAN code:
ADC3-60M: 8595188133012
Order Code: 3301

Technical parameters	ADC3-60M
Input	
Analog inputs:	6x voltage, current or temperature input
Number of inputs:	6
Galv. separation from inner circuits:	no
Diagnostic:	indication (exceeding the range, interruption of a sensor or overload of Uref output) by the applicable red LED
Common terminal:	COM
Converter resolution:	14 bits
Input resistance	
- for voltage ranges:	approx. 150 kΩ
- for current ranges:	100 Ω
Types of inputs/measuring ranges*:	Voltage (U): 0 ÷ +10 V (U); 0 ÷ +2 V (U) Current (I): 0 ÷ +20 mA (I); 4 ÷ +20 mA (I) temperature: input at ext. temperature sensor TC, TZ see accessories/according to used sensor from -40 °C to 125 °C
Outputs of the Uref1 and Uref2 voltage	
Voltage*/current of Uref1:	10 or 15 V DC/100 mA
Voltage*/current of Uref2:	10 V DC/20 mA
Communication	
Installation BUS:	BUS
Unit status indication:	green LED RUN
Power supply	
Supply voltage/tolerance:	27 V DC, -20/+10 %
Dissipated power:	max. 1 W
Rated current:	100 mA (at 27 V DC), from BUS
Connection	
Terminal:	max. 2.5 mm ² /1.5 mm ² with sleeve
Operating conditions	
Operating temperature:	-20 to +55 °C
Storing temperature:	-30 to +70 °C
Protection degree:	IP20 device, IP40 mounting in the switchboard
Overvoltage category:	II.
Pollution degree:	2
Operating position:	any
Installation:	into a switchboard rail to DIN EN 60715
Design:	3-MODULE
Dimensions and weight	
Dimensions:	90 x 52 x 65 mm
Weight:	112 g
Standards:	EN 63044-1

* selectable for each input/output individually by configuration in the user program iDM3. Min. supply voltage 24 V DC must be respected when configuring 15 V DC and 100 mA consumption.

** according to load Uref output.

- ADC3-60M is an analog-to-digital converter and is equipped with 6 analog inputs.
- Analog inputs serve to connect temperature sensors or analog sensors that generates current or voltage signal.
- The analog inputs have a resolution of a 14-bit AD converter.
- The analog inputs have a common terminal COM.
- Analog inputs/outputs are configurable in iDM3 independently as voltage (U) or current (I) or temperature.
- We recommend Clima sensor as a meteo station. There are four types: five to eight outputs. The top series offers measuring of: rainfall, brightness, twilight, speed of wind, temperature and relative humidity.
- The red LEDs in the front panel indicate exceeding the range, interruption of a sensor or overload of Uref output.
- The temperature inputs at the top of the terminal are used to connect the following temperature sensors: TC, TZ.
- ADC3-60M in 3-MODULE version is designed for mounting into a switchboard, on a DIN rail EN60715.

Connection

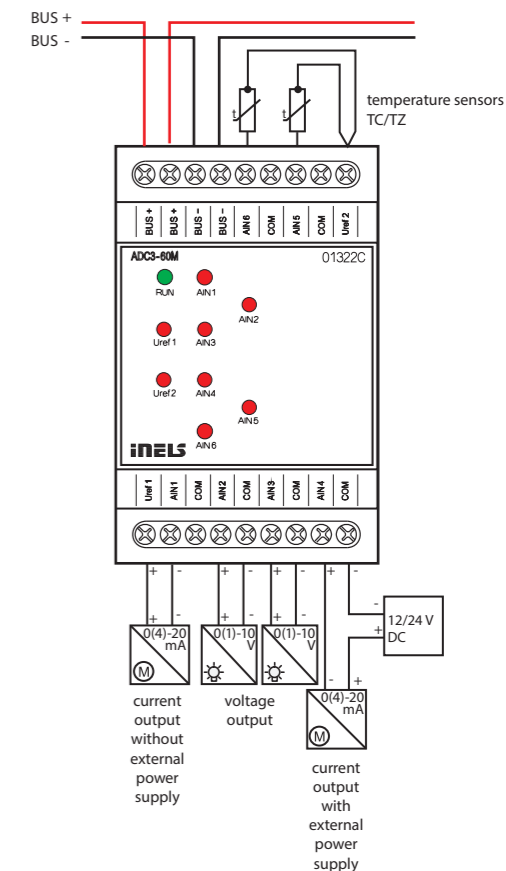



EAN code
DAC3-04M: 8595188132565
Order Code: 3256

Technical parameters DAC3-04M

Input	
Temperature measuring:	yes, input for external temperature sensor TC/TZ
Range/accuracy of temp. measuring:	-20 to +120 °C; 0.5 °C from the range
Outputs	
Analog voltage output/rated current:	4x 0(1)-10 V/10 mA
Indication of output overload:	red LED OVERLOAD
Communication	
Installation BUS:	BUS
Status indication unit:	green LED RUN
Power supply	
Supply voltage/tolerance:	27 V DC, -20/+10 %
Dissipated power:	max. 1 W
Rated current:	50 mA (at 27 V DC), from BUS
Connection	
Terminal:	max. 2.5 mm ² /1.5 mm ² with sleeve
Operating conditions	
Air humidity:	max. 80 %
Operating temperature:	-20 to +55 °C
Storing temperature:	-30 to +70 °C
Protection degree:	IP20 device, IP40 mounting in the switchboard
Overvoltage category:	II.
Pollution degree:	2
Operating position:	any
Installation:	switchboard on DIN rail EN 60715
Design:	3-MODULE
Dimensions and weight	
Dimensions:	90 x 52 x 65 mm
Weight:	108 g
Standards:	EN 63044-1

- DAC3-04M is a converter from a digital signal to an analog voltage signal.
- The converter generates 4 analog voltage signals, which can be operated, according to type of controlled device, in a range 0-10 V or 1-10 V.
- This is used for regulating and controlling devices that may be controlled by this signal (dimnable ballasts of fluorescent lamps and other types of light sources - e.g. LED panels from the assortment of ELKO Lighting, dimming actuator for LED and RGB strips RFDA-73M/RGB, thermo drives, servo drives, elements for measuring and regulation and others).
- Range of output voltage is adjustable in iDM3.
- Converter is equipped with a temperature input for connecting a 2-wire external sensor TC/TZ (see accessories).
- DAC3-04M in 3-MODULE version is designed for mounting into a switchboard, on DIN rail EN60715.

Connection

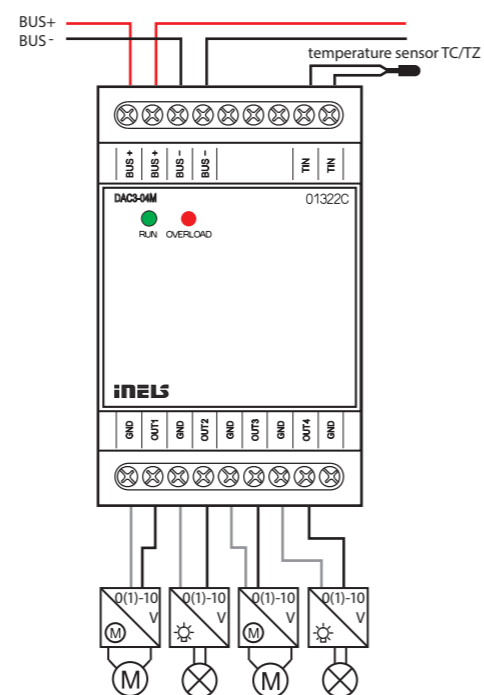

EAN code
DAC3-04B: 8595188132572

Technical parameters DAC3-04B

Input	
Temperature measuring:	YES, input for external temperature sensor TC/TZ
Range / accuracy of temp. measuring:	-20 to +120°C; 0.5°C from the range
Outputs	
Analog voltage output / rated current:	4x 0(1)-10 V/10 mA
Communication	
Installation BUS:	BUS
Status indication unit:	green LED RUN
Power supply	
Supply voltage / tolerance:	27 V DC, -20 / +10 %
Dissipated power:	max. 1 W
Rated current:	50 mA (at 27V DC), from BUS
Connection	
Terminal:	0.5 - 1 mm ²
Operating conditions	
Operating temperature:	-20 to +55 °C
Storing temperature:	-30 to +70 °C
Protection degree:	IP30
Overvoltage category:	II.
Pollution degree:	2
Operating position:	any
Installation:	into installation box
Dimensions and weight	
Dimensions:	49 x 49 x 13 mm
Weight:	27 g

- DAC3-04B is converter of a digital signal to an analog voltage signal.
- The converter generates 4 analog voltage signals, which can be regulated according to type of controlled device, in a range 0-10 V or 1-10 V.
- This is used for regulating and controlling devices that may be controlled by this signal (dimnable ballasts of fluorescent lamps and other types of light sources - e.g. LED panels from the assortment of ELKO Lighting, dimming actuator for LED and RGB strips RFDA-73M/RGB, thermostatic heads, servo drives, elements for measuring and regulation and others).
- Range of output voltage is adjustable in iDM3.
- DAC3-04B is equipped with a temperature input for connecting a 2-wire external sensor TC / TZ.
- DAC3-04B in version B is designed for mounting into an installation box.

Connection

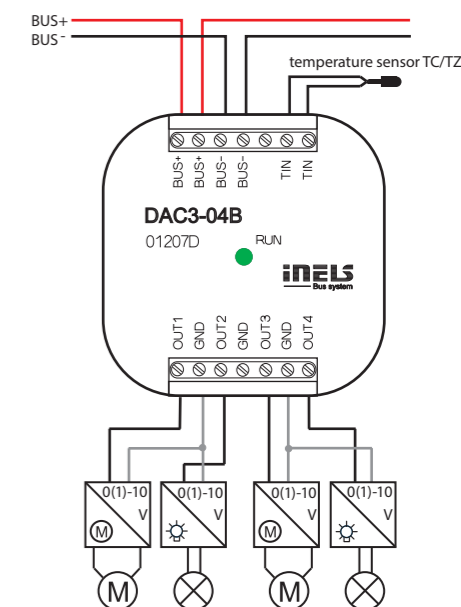

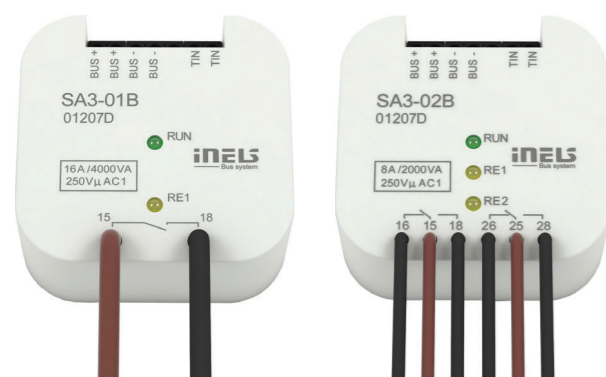

EAN code
SA3-01B: 8595188132350
SA3-02B: 8595188132367

Order Code:
SA3-01B: 3235
SA3-02B: 3236

Technical parameters	SA3-01B	SA3-02B
Inputs		
Temperature measuring:	Yes, input for external thermo sensor TC, TZ	
Scope and accuracy of tem.meas.:	-20 to +120°C; 0.5°C from the range	
Outputs		
Output:	1x NO 16 A	2x CO 8 A
Switching voltage:	250 V AC, 24 V DC	
Switched load:	4000 VA/AC1, 384 W/DC	2000 VA/AC1, 192 W/DC
Surge current:	30 A; max. 4 s. when repeating 10%	10 A
Output relays separated from all internal circuits:	reinforced insulation (Cat. II surges by EN 60664-1)	
Insulation voltage between relay outputs RE1-RE2:	x	basic isolation (Cat. II surges by EN 60664-1)
Minimal switching current:	100 mA/5 V	
Switching frequency/no load:	1200 min ⁻¹	300 min ⁻¹
Switching frequency/rated load:	6 min ⁻¹	15 min ⁻¹
Mechanical lifetime:	3x 10 ⁷	1x 10 ⁷
Electrical lifetime for AC1:	0.7x 10 ⁵	1x 10 ⁵
Output indication:	yellow LED	2x yellow LED
Communication		
Installation BUS:	BUS	
Power supply		
Supply voltage/tolerance:	27 V DC, -20/+10 %	
Dissipated power:	max. 4 W	
Rated current:	30 mA (at 27 V DC)	50 mA (at 27 V DC)
Status indication unit:	green LED RUN	
Connection		
Data terminals:	terminal, 0.5 - 1 mm ²	
Power outputs:	2x conduct. CY, Ø 2.5 mm ²	6x conduct. CY, Ø 0.75 mm ²
Operating conditions		
Operating temperature:	-20 to +55 °C	
Storage temperature:	-30 to +70 °C	
Protection degree:	IP30	
Overvoltage category:	II.	
Pollution degree:	2	
Operation position:	any	
Installation:	into installation box	
Dimensions and weight		
Dimensions:	49 x 49 x 21 mm	
Weight:	50 g	50 g
Standards:	EN 63044-1	

- Actuators are designed for switching of one (SA3-01B), respectively two (SA3-02B) of various appliances and loads by relay outputs (potentialless contacts).
- SA3-01B contains 1 relay with switching potentialless contact with max. load 16 A/4000 VA/AC1.
- SA3-02B contains 2 relays with switching potentialless contacts with max. load 8 A/2000 VA/AC1.
- Output contacts are separately controllable and addressable.
- Thanks to changeover contacts, the SA3-02B actuator can be used to control a 230 V drive (such as blinds, shutters or awnings), where as by proper bridging of contacts, it is possible to secure locking hardware options while switching on phase two outputs.
- Actuators are equipped with a temperature input for connecting an external two-wire temperature sensor TC/TZ (see accessories).
- LED on front panel signals state of each output.
- SA3 is normally supplied in the option AgSnO₂ contact material.
- SA3-01B, SA3-02B are designed for mounting into the installation box.

Connection

SA3-01B

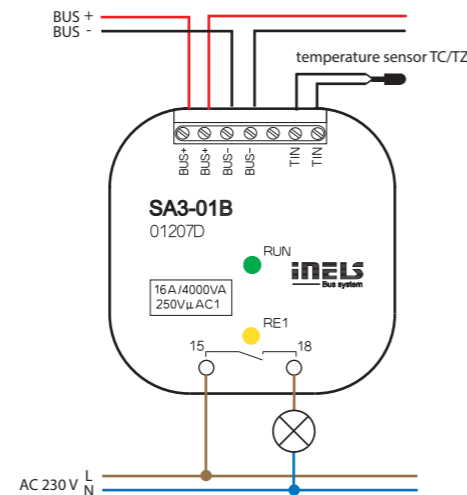

SA3-02B

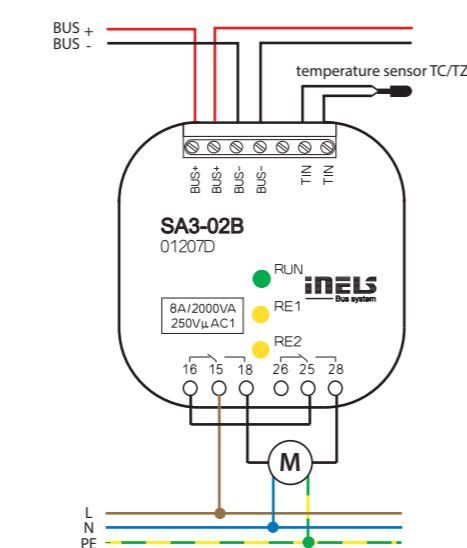

EAN code
SA3-04M: 8595188132381
Order Code: 3238

Technical parameters	SA3-04M
Outputs	
Output:	4x changeover 16 A/AC1
Switching voltage:	250 V AC, 24 V DC
Switching output:	4000 VA/AC1, 384 W/DC
Surge current:	30 A; max. 4 s. at 10% duty cycle
Output relays separated from all internal circuits:	reinforced insulation (Cat. II surges by EN 60664-1)
Isolation between relay outputs RE1-3 and RE4:	reinforced insulation (Cat. II surges by EN 60664-1)
Isolation between relay outputs RE1-3:	basic insulated (Cat. II surges by EN 60664-1)
Isolates. voltage open relay contact:	1 kV
Min. switched current:	100 mA
Switching frequency/no load:	1200 min ⁻¹
Switching frequency/rated load:	6 min ⁻¹
Mechanical life:	3x 10 ⁷
Electrical life AC1:	0.7x 10 ⁵
Output indication:	4x yellow LED
Communication	
Installation BUS:	BUS
Power supply	
Supply voltage/tolerance:	27 V DC, -20/+10 %
Dissipated power:	max. 4 W
Rated current:	70 mA (at 27 V DC), from BUS
Status indication unit:	green LED RUN
Connection	
Terminal:	max. 2.5 mm ² /1.5 mm ² with sleeve
Operating conditions	
Air humidity:	max. 80 %
Operating temperature:	-20 to +55 °C
Storing temperature:	-30 to +70 °C
Protection degree:	IP20 device, IP40 mounting in the switchboard
Overvoltage category:	II.
Pollution degree:	2
Operation position:	any
Installation:	switchboard on DIN rail EN 60715
Design:	3-MODULE
Dimensions and weight	
Dimensions:	90 x 52 x 65 mm
Weight:	164 g
Standards:	EN 63044-1

- SA3-04M is a switching actuator containing 4 independent relays with changeover potential-free contacts.
- Maximum load per contact is 16 A/4000 VA/AC1.
- Each of the 4 outputs contacts are individually controllable and addressable.
- All four relays are individually decorated input terminals, and therefore can switch various independent potentials.
- The actuator is designed for switching 4 various appliances or loads by relay outputs (potential free contacts).
- Thanks to changeover contacts, it can be used to control up to two drives 230 V power (such as blinds, shutters or awnings) with appropriate bridging, the contacts can secure hardware blocking the possibility of simultaneous switching of the phase on both outputs, see example of connection.
- LEDs on the front panel signal the status of each output.
- Contact status of each relay can be changed separately and manually by control buttons on a front panel.
- Switching actuators SA3 is normally supplied in the option AgSnO₂ contact material.
- SA3-04M in 3-MODULE version is designed for mounting into a switchboard, on DIN rail EN60715.

Connection

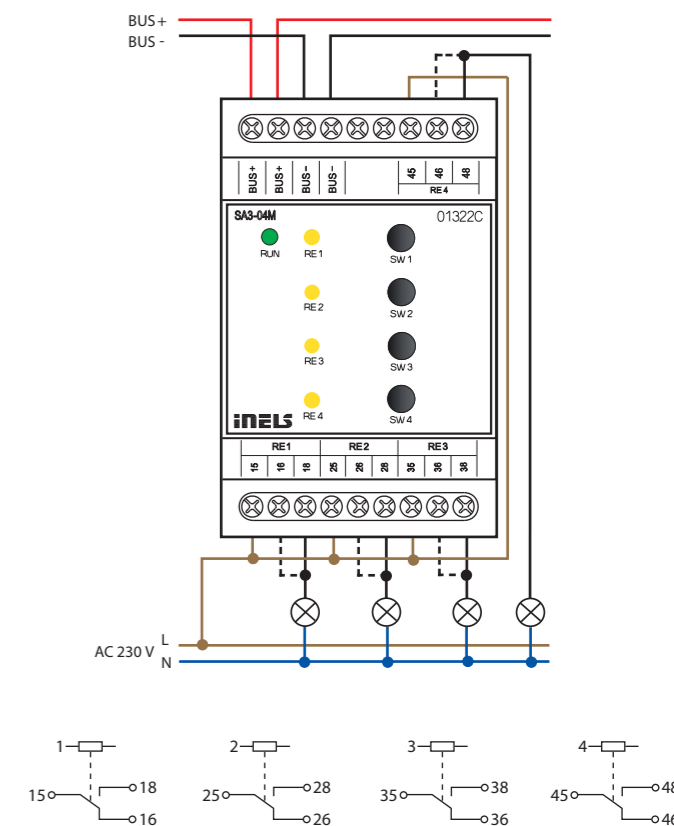



EAN code
SA3-06M: 8595188132879
Order Code: 3287

Technical parameters SA3-06M

Outputs	
Output:	6x changeover 8 A/AC1
Switching voltage:	250 V AC, 24 V DC
Switching output:	2000 VA/AC1, 192 W/DC
Surge current:	10 A
Output relays separated from all internal circuits:	reinforced insulation (Cat. II surges by EN 60664-1)
Isolation between relay outputs COM1 and COM2:	reinforced insulation (Cat. II surges by EN 60664-1)
Isolation between individual relay outputs:	basic insulated (Cat. II surges by EN 60664-1)
Isolates voltage open relay contact:	1 kV
Max. current terminals COM1 and COM2:	16 A
Min. switched current:	100 mA/5 V DC
Switching frequency/no load:	300 min ⁻¹
Switching frequency/rated load:	15 min ⁻¹
Mechanical life:	2x 10 ⁷
Electrical life AC1:	5x 10 ⁴
Output indication:	6x yellow LED
Communication	
Installation BUS:	BUS
Power supply	
Supply voltage/tolerance:	27 V DC, -20/+10 %
Dissipated power:	max. 9 W
Rated current:	60 mA (at 27 V DC), from BUS
Status indication unit:	green LED RUN
Connection	
Terminal:	max. 2.5 mm ² /1.5 mm ² with sleeve
Operating conditions	
Air humidity:	max. 80%
Operating temperature:	-20 to +55 °C
Storing temperature:	-30 to +70 °C
Protection degree:	IP20 device, IP40 mounting in the switchboard
Overvoltage category:	II.
Pollution degree:	2
Operation position:	any
Installation:	switchboard on DIN rail EN 60715
Design:	3-MODULE
Dimensions and weight	
Dimensions:	90 x 52 x 65 mm
Weight:	160 g
Standards:	EN 63044-1

- The actuator is designed for switching up to six various appliances and loads with potentialless contact.
- SA3-06M is a switching actuator contains 6 independent relays with changeover potentialless contacts.
- Maximum load per contact is 8 A/2000 VA/AC1.
- Each of six output contacts are individually controllable and addressable.
- The relays are divided into two groups, the group of four relays on the bottom terminal switches the common potential, a pair of relays on top of the terminal switches the second common potential.
- The actuator is suitable for operating discontinuously controlled thermo drives in the distributor of floor heating.
- LEDs on the front panel signals the status of each output.
- Contact status of each relay can be changed separately and manually by control buttons on a front panel.
- SA3-06M is normally supplied in the option AgSnO₂ contact material.
- SA3-06M in 3-MODULE version is designed for mounting into a switch-board/DIN rail EN60715.

Connection

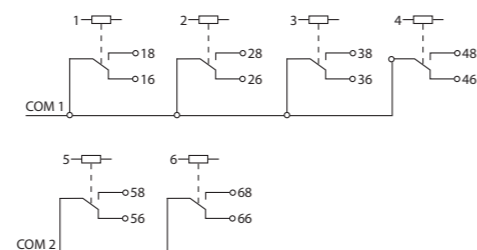
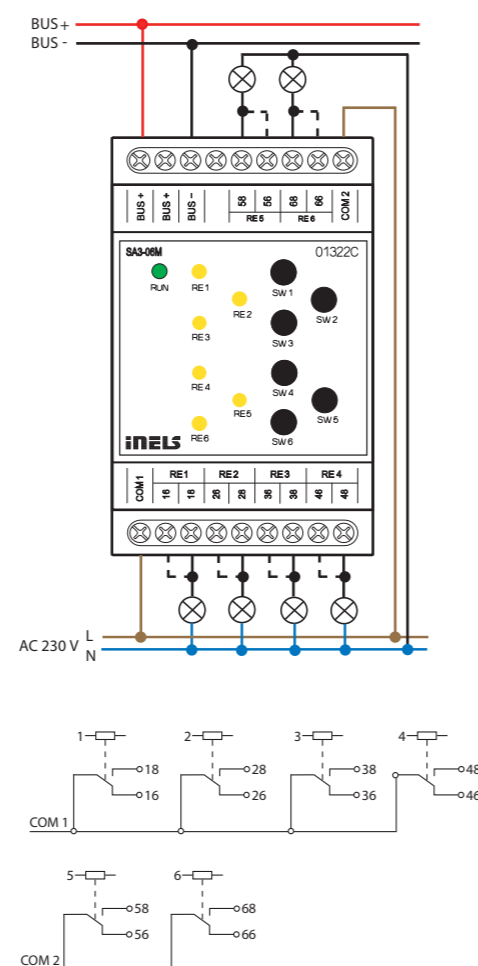

EAN code
SA3-014M: 8595188191241
Order Code: 9124

Technical parameters SA3-014M

Outputs	
Output:	14x switching 10 A/AC1
Switched voltage:	250 V AC, 30 V DC
Switched output:	2500 VA/AC, 150 W/DC
Protection:	10A (maximum output) B class circuit breaker
Peak current:	10 A
Output relays separated from all internal circuits:	reinforced insulation (Cat. II surges by EN 60664-1)
Isolation between relay outputs COM 1,2 COM 3,4 COM 5,6 COM 7,8 COM 9,10 COM 11,12:	reinforced insulation (Cat. II surges by EN 60664-1)
Isolates voltage open relay contact:	1 kV
Max. current of one common terminal:	12 A
Minimal switched current:	100 mA/10 V DC
Switching frequency without load:	300 min ⁻¹
Switching frequency with rated load:	15 min ⁻¹
Mechanical life:	1x 10 ⁷
Electrical life AC1:	1x 10 ⁵
Mains voltage detection:	yes (relay switching in zero)
Output indication:	14x yellow LED
Control:	14x buttons front panel
Communication	
Installation BUS:	BUS
Status indication unit:	green LED RUN - status led for relay
Power supply	
Voltage of BUS/tolerance/nominal current:	27 V DC, -20/+10 %, 150 mA
Connection	
Terminal:	max. 2.5 mm ² /1.5 mm ² with sleeve
Operating conditions	
Operating temperature:	-20 to +55 °C
Storing temperature:	-30 to +70 °C
Protection degree:	IP20 device, IP40 mounting in the switchboard
Overvoltage category:	II.
Pollution degree:	2
Operating position:	any
Installation:	switchboard on DIN rail EN 60715
Design:	6-MODULE
Dimensions and weight	
Dimensions:	90 x 105 x 65 mm
Weight:	310 g
Standards:	EN 63044-1

Note:
For the protection of relay it is recommended to use protection device: 10A (maximum output) B class circuit breaker.

- SA3-014M is a switching actuator containing 14 independent relays with NO potentialless contacts, with the fact that switches the same potential. Maximal loadability of contacts is 10A/2500 VA/AC1.
- Each of the fourteen output contacts are individually controllable and addressable.
- Actuator SA3-014M is powered by an bus voltage 27V DC.
- The unit's status is indicated by the green RUN LED on the front panel - if the bus supply is connected, but there is no communication via BUS with master, the LED RUN is on continuously. - if the bus voltage is connected and the unit communicates by BUS, the LED RUN flashes.
- Contact status of each relay can be changed separately and manually by control buttons on a front panel.
- The unit has synchronized closing and opening of the relay in the zero-voltage of the sinusoidal waveform. The sync inputs are COM 1, 3, 5, 7, 9, 11 and 13 against the N terminal.
- SA3-014M is normally supplied in the option AgSnO₂ contact material. SA3-014M in design 6-MODULE is designed to be mounted into a switchboard, on to DIN rail EN60715.
- The status of the output contacts is indicated by the LED: - when the output is changed, the corresponding LED lights up.

Connection

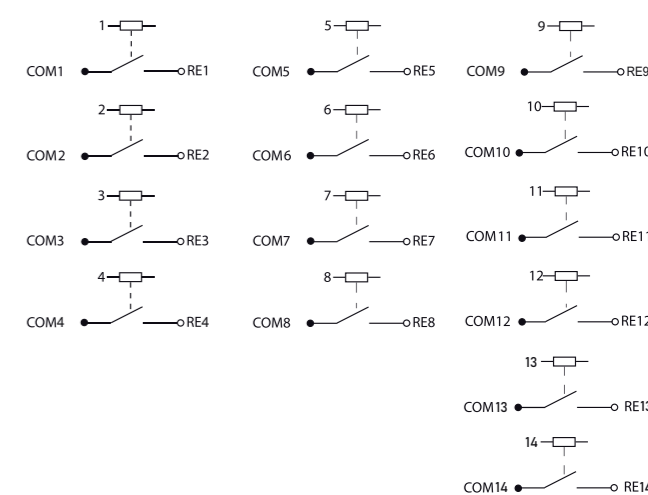
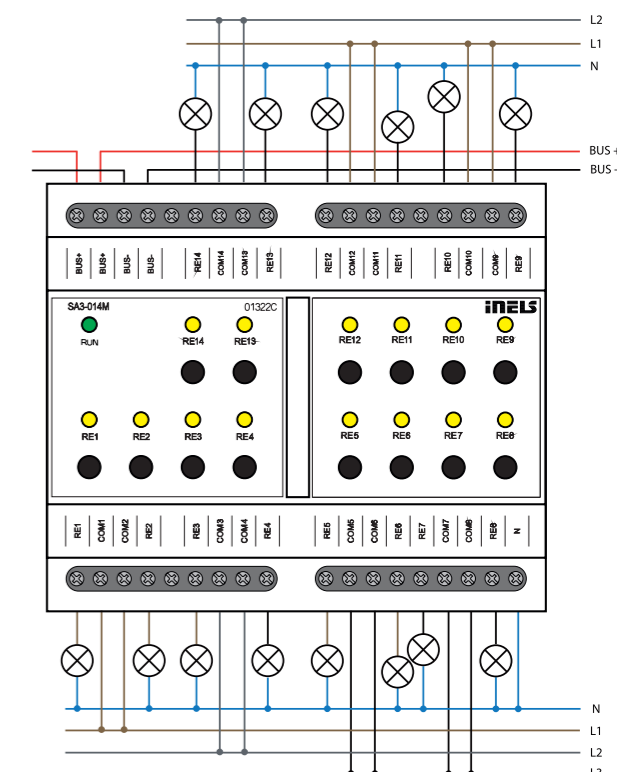



EAN code
SA3-014M/E: 8595188189187
Order Code: 8918

Technical parameters		SA3-014M/E
Outputs		
Output:	14x switching 10 A/AC1	
Switched voltage:	250 V AC, 30 V DC	
Switched output:	2500 VA/AC, 150 W/DC	
Protection:	10A (maximum output) B class circuit breaker	
Peak current:	10 A	
Output relays separated from all internal circuits:	reinforced insulation (Cat. II surges by EN 60664-1)	
Isolation between relay outputs COM 1,2 COM 3,4 COM 5,6 COM 7,8 COM 9,10 COM 11,12:	reinforced insulation (Cat. II surges by EN 60664-1)	
Isolates. voltage open relay contact:	1 kV	
Max. current of one common terminal:	12 A	
Minimal switched current:	100 mA/10 V DC	
Switching frequency without load:	300 min ⁻¹	
Switching frequency with rated load:	15 min ⁻¹	
Mechanical life:	1x 10 ⁷	
Electrical life AC1:	1x 10 ⁵	
Mains voltage detection:	yes (relay switching in zero)	
Output indication:	-	
Control:	-	
Communication		
Installation BUS:	BUS	
Status indication unit:	green LED RUN	
Power supply		
Voltage of BUS/tolerance/nominal current:	27 V DC, -20/+10 %, 150 mA	
Connection		
Terminal:	max. 2.5 mm ² /1.5 mm ² with sleeve	
Operating conditions		
Operating temperature:	-20 to +55 °C	
Storing temperature:	-30 to +70 °C	
Protection degree:	IP20 device, IP40 mounting in the switchboard	
Overvoltage category:	II.	
Pollution degree:	2	
Operating position:	any	
Installation:	switchboard on DIN rail EN 60715	
Design:	6-MODULE	
Dimensions and weight		
Dimensions:	90 x 105 x 65 mm	
Weight:	310 g	
Standards:	EN 63044-1	

- SA3-014M/E is a switching actuator containing 14 independent relays with NO potentialless contacts, with the fact that switches the same potential. Maximal loadability of contacts is 10A/2500 VA/AC1.
- Each of the fourteen output contacts are individually controllable and addressable. Actuator SA3-014M/E is powered by an bus voltage 27V DC.
- The unit's status is indicated by the green RUN LED on the front panel - if the bus supply is connected, but there is no communication via BUS with master, the LED RUN is on continuously.
 - if the bus voltage is connected and the unit communicates by BUS, the LED RUN flashes.
- Contact status of each relay can be changed separately and manually by control buttons on a front panel.
- The unit has synchronized closing and opening of the relay in the zero-voltage of the sinusoidal waveform. The sync inputs are COM 1, 3, 5, 7, 9, 11 and 13 against the N terminal.
- SA3-014M/E is normally supplied in the option AgSnO2 contact material. SA3-014M/E in design 6-MODULE is designed to be mounted into a switchboard, on to DIN rail EN60715.
- SA3-014M/E is an economic option without manual control buttons on the front panel and status LEDs for the relay output. (possibility to control via iDM software).

Connection

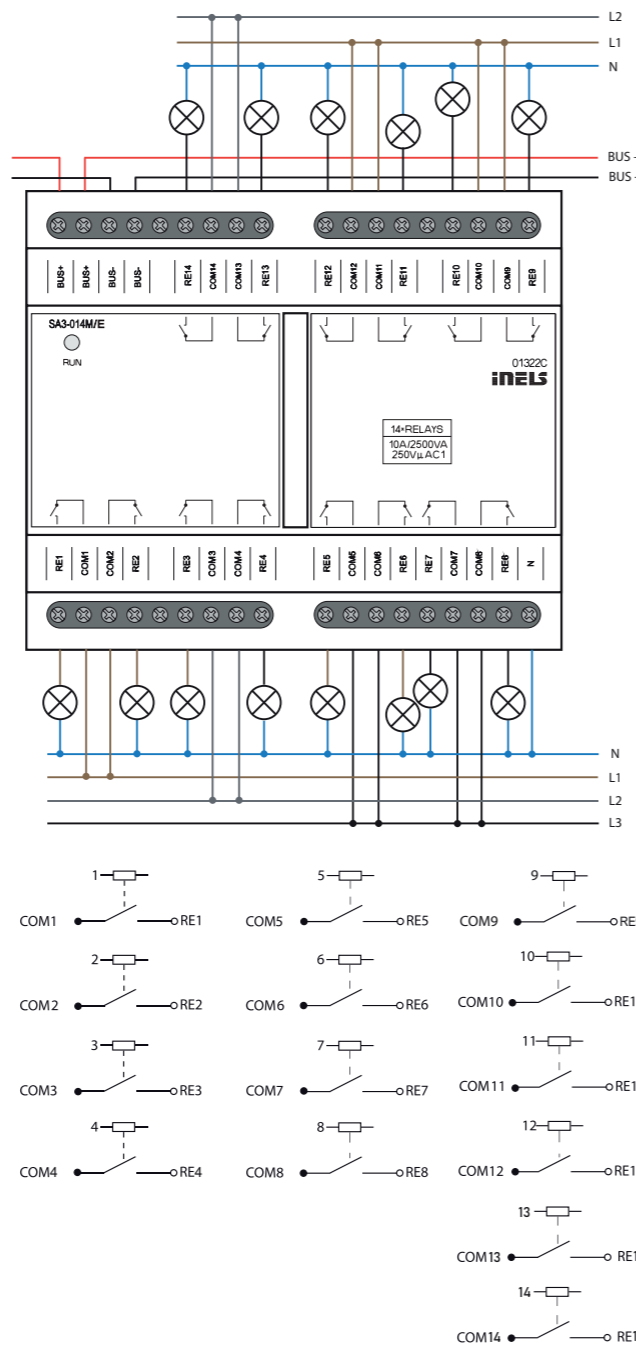

Note:
For the protection of relay it is recommended to use protection device: 10A (maximum output) B class circuit breaker.

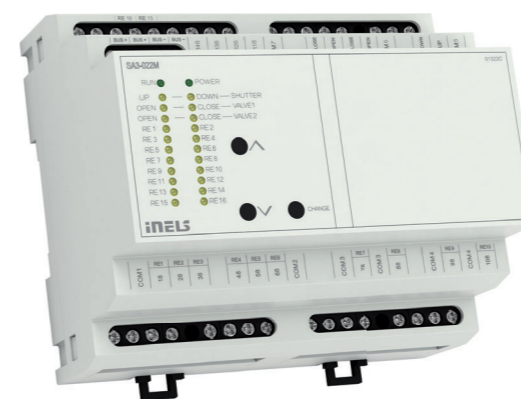

EAN code
SA3-022M: 8595188135269
Order Code: 3526

Technical parameters		SA3-022M
Outputs		
Output indication:	yellow LED	
Output relays separated from all internal circuits:	reinforced insulation (Cat. II surges by EN 60664-1)	
Isolation between COM potentials:	reinforced insulation (Cat. II surges by EN 60664-1)	
Isolates. voltage open relay contact:	1 kV	
SSR (Electronic Relay):	4x switching (VALVE1-VALVE2)	
Switching voltage:	20 - 240 V AC	
Switching output:	480 VA	
Surge current:	20 A, t ≤ 16 ms	
Relay 6A:	12x switching (RE1 - RE6, RE11 - RE16), 1x HW block changeover (OUT1, OUT2)	
Switching voltage:	250 V AC, 24 V DC	
Switching output:	1500 VA/AC1; 300 VA/AC15; 180 W/DC, AC3	
Minimum switching load:	500 mW (12 V/10 mA)	
Mechanical life:	10x10 ⁶	
Electrical life AC1:	6x10 ⁴	
Relay 10A:	4x switching (RE7 - RE10)	
Switching voltage:	250 V AC, 24 V DC	
Switching output:	2500 VA/AC1, 240 W/DC	
Surge current:	30 A max. 4 s at 10%	
Minimal switched current:	100 mA	
Switching frequency without load:	1200 min ⁻¹	
Switching frequency with rated load:	6 min ⁻¹	
Mechanical life:	3x 10 ⁷	
Electrical life AC1:	0.7x 10 ⁵	
Communication		
Installation BUS:	BUS	
Unit status indication:	green LED POWER	
Power supply		
Supply voltage/tolerance:	27 V DC, -20/+10 %	
Dissipated power:	max. 3 W	
Rated current:	100 mA (at 27 V DC), from BUS	
Power status indication:	green LED RUN	
Connection		
Terminal:	max. 2.5 mm ² /1.5 mm ² with sleeve	
Operating conditions		
Operating temperature:	-20 to +55 °C	
Storing temperature:	-30 to +70 °C	
Protection degree:	IP20 device, IP40 mounting in the switchboard	
Overvoltage category:	II.	
Pollution degree:	2	
Operating position:	any	
Installation:	switchboard on DIN rail EN 60715	
Design:	6-MODULE	
Dimensions and weight		
Dimensions:	90 x 105 x 65 mm	
Weight:	307 g	
Standards:	EN 63044-1	

- Equipped with 22 relay outputs (of which 1x changeover contact - roller blinds, blinds).
- Switch lighting and socket circuits (6 A and 10 A relay) with common potential at the "COMx" terminal.
- Control of roller blinds, blinds (24 - 230 V AC/DC).
- Relay control of the fan coil unit - heating/cooling, 3 fan speeds (24 - 230 V AC/DC).
- Connection to BUS, communication with CU3.
- The front panel LEDs indicate the status of each output.
- SA3-022M in design 6-MODULE is designed to be mounted into a switchboard, onto DIN rail EN60715.

Connection

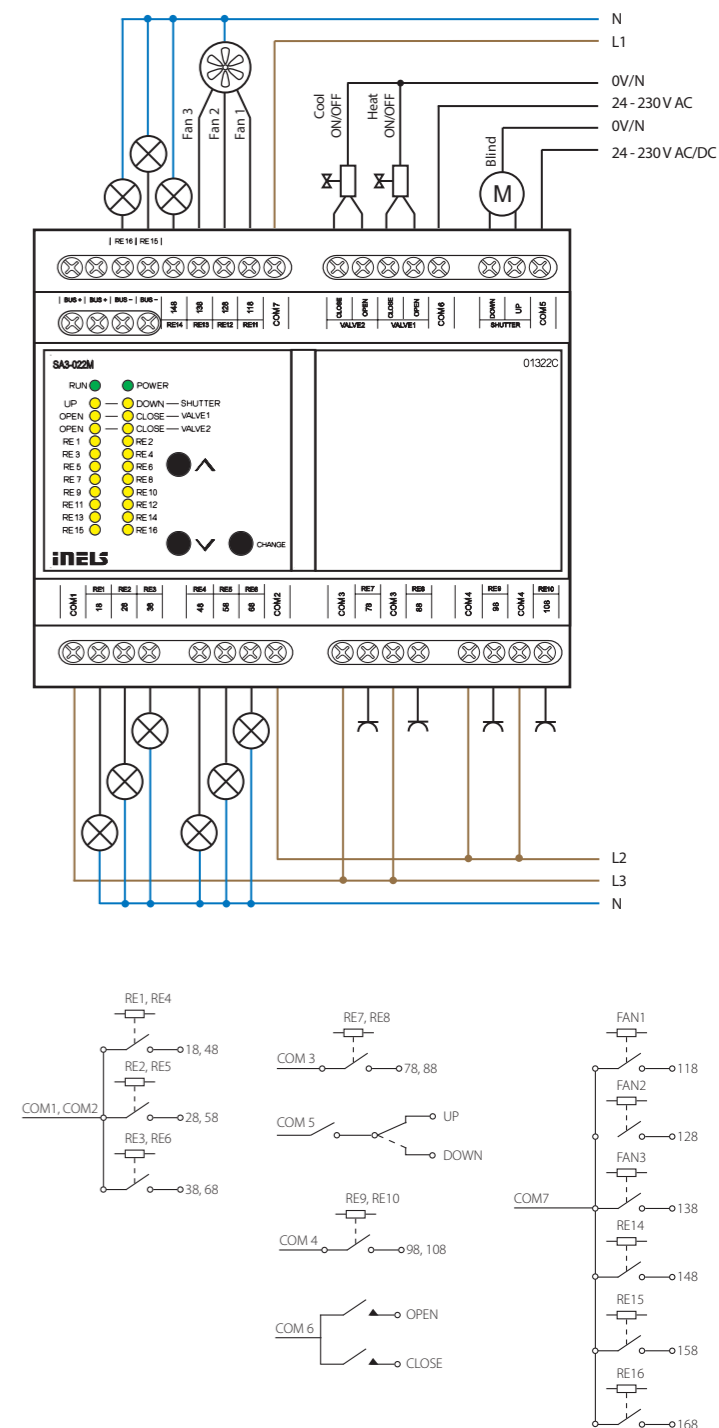



EAN code
EA3-022M: 8595188135238
Order Code: 3523

- Equipped with 22 relay outputs (of which 1x changeover contact – roller blinds, blinds).
- Switch lighting and socket circuits (6 A and 10 A relay) with common potential at the "COMx" terminal.
- Control of roller blinds, blinds (24 - 230 V AC/DC).
- Relay control of the fan coil unit - heating/cooling, 3 fan speeds (24 - 230 V AC/DC).
- Connection to BUS, communication with CU3.
- EA3-022M in design 6-MODULE is designed to be mounted into a switchboard, onto DIN rail EN60715.

Connection

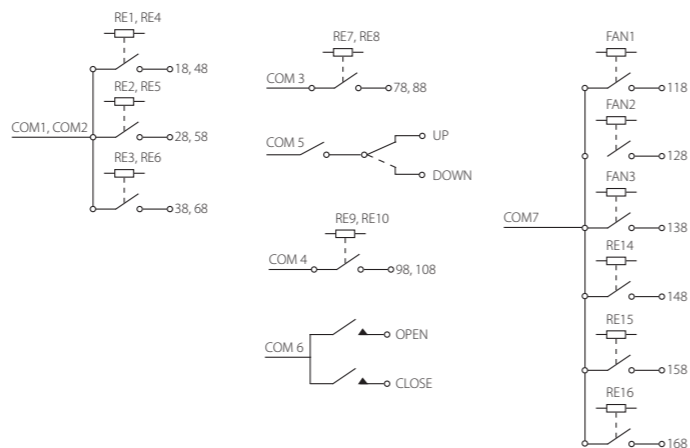
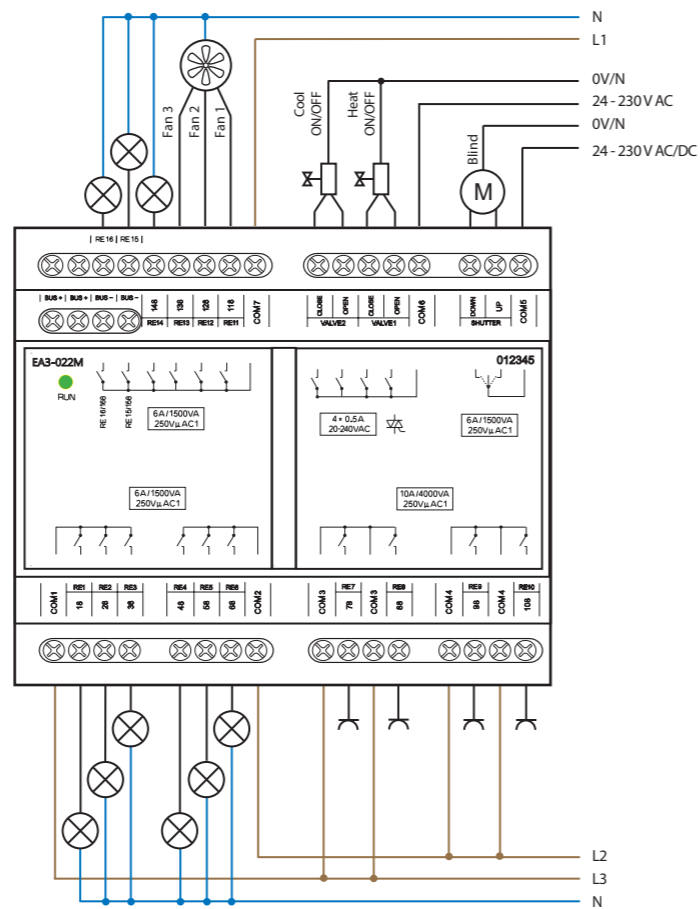

Technical parameters		EA3-022M
Outputs		
Output relays separated from all internal circuits:	reinforced insulation	(Cat. II surges by EN 60664-1)
Insulation between COM potentials:	reinforced insulation	(Cat. II surges by EN 60664-1)
Isolates. voltage open relay contact:	1 kV	
SSR (Electronic Relay):	4x switching (VALVE1-VALVE2)	
Switching voltage:	20 - 240 V AC	
Switching output:	480 VA	
Surge current:	20 A, t ≤ 16 ms	
Relay 6 A:	12x switching (RE1 - RE6, RE11 - RE16), 1x HW block changeover (OUT1, OUT2)	
Switching voltage:	250 V AC, 24 V DC	
Switching output:	1500 VA/AC1; 300 VA/AC15; 180 W/DC, AC3	
Minimum switching load:	500 mW (12 V/10 mA)	
Mechanical life:	10x10 ⁶	
Electrical life AC1:	6x10 ⁴	
Relay 10 A:	4x switching (RE7 - RE10)	
Switching voltage:	250 V AC, 24 V DC	
Switching output:	2500 VA/AC1, 240 W/DC	
Surge current:	30 A max. 4 s at 10 %	
Minimal switched current:	100 mA	
Switching frequency without load:	1200 min ⁻¹	
Switching frequency with rated load:	6 min ⁻¹	
Mechanical life:	3x 10 ⁷	
Electrical life AC1:	0.7x 10 ⁵	
Communication		
Installation BUS:	BUS	
Unit status indication:	green LED RUN	
Power supply		
Supply voltage/tolerance:	27 V DC, -20/+10 %	
Dissipated power:	max. 2 W	
Rated current:	100 mA (at 27 V DC), from BUS	
Connection		
Terminal:	max. 2.5 mm ² /1.5 mm ² with sleeve	
Operating conditions		
Operating temperature:	-20 to +55 °C	
Storing temperature:	-30 to +70 °C	
Protection degree:	IP20 device, IP40 mounting in the switchboard	
Overvoltage category:	II.	
Pollution degree:	2	
Operating position:	any	
Installation:	switchboard on DIN rail EN 60715	
Design:	6-MODULE	
Dimensions and weight		
Dimensions:	90 x 105 x 65 mm	
Weight:	337 g	
Standards:	EN 63044-1	



EAN code
JA3-014M: 8595188191258
Order Code: 9125

- JA3-014M is an actuator designed for controlling rollers, shutters, blinds, awnings, garage doors, entrance gates, etc.
- It controls electric drives that are controlled in two directions and have a built-in limit switch.
- The unit's status is indicated by the green RUN LED on the front panel
 - if the BUS voltage is connected, but there is no communication via BUS with master, the LED RUN is on continuously.
 - if the bus voltage is connected and the unit communicates by BUS, the LED RUN flashes.
- The status of the output contacts is indicated by the Up/ Down LED:
 - when the blind/roller blind is moving up/down, the corresponding LED lights up.
 - if the number of switching operations per minute is exceeded, the corresponding LED flashes.
- Contact status of each relay JA3-014M can be changed separately and manually by control buttons on a front panel.
- The software blocking of output relay contacts can be secure using the iNELS Design Manager software.
- JA3-014M is normally supplied in the option AgSnO2 contact material.
- JA3-014M in 6-MODULE version is designed for mounting into a switchboard on DIN rail EN60715.
- The unit has synchronized closing and opening of the relay in the zero voltage of the sinusoidal waveform. The sync inputs are COM 1, 2, 3, 4, 5, 6 and 7 against the N terminal.

Technical parameters

Technical parameters		JA3-014M
Outputs		
Output:	14x switching 0.5 A/AC15	
Switched voltage:	250 V AC, 30 V DC	
Switched output:	125 VA/AC15	
Protection:	10A (maximum output) B class circuit breaker	
Peak current:	10 A	
Output relays separated from all internal circuits:	reinforced insulation	(Cat. II surges by EN 60664-1)
Isolation between relay outputs COM 1,2 COM 3,4 COM 5,6 COM 7,8 COM 9,10 COM 11,12:	reinforced insulation	(Cat. II surges by EN 60664-1)
Isolates. voltage open relay contact:	1 kV	
Max. current of one common terminal:	12 A	
Minimal switched current:	100 mA/10 V DC	
Switching frequency without load:	300 min ⁻¹	
Switching frequency with rated load:	15 min ⁻¹	
Mechanical life:	1x 10 ⁷	
Electrical life AC1:	1x 10 ⁵	
Mains voltage detection:	yes (relay switching in zero)	
Output indication:	14x yellow LED	
Control:	14x buttons front panel	
Communication		
Installation BUS:	BUS	
Status indication unit:	green LED RUN - status led for relay	
Power supply		
Voltage of BUS/tolerance/nominal current:	27 V DC, -20/+10 %, 150 mA	
Connection		
Terminal:	max. 2.5 mm ² /1.5 mm ² with sleeve	
Operating conditions		
Operating temperature:	-20 to +55 °C	
Storing temperature:	-30 to +70 °C	
Protection degree:	IP20 device, IP40 mounting in the switchboard	
Overvoltage category:	II.	
Pollution degree:	2	
Operating position:	any	
Installation:	switchboard on DIN rail EN 60715	
Design:	6-MODULE	
Dimensions and weight		
Dimensions:	90 x 105 x 65 mm	
Weight:	310 g	
Standards:	EN 63044-1	

Connection

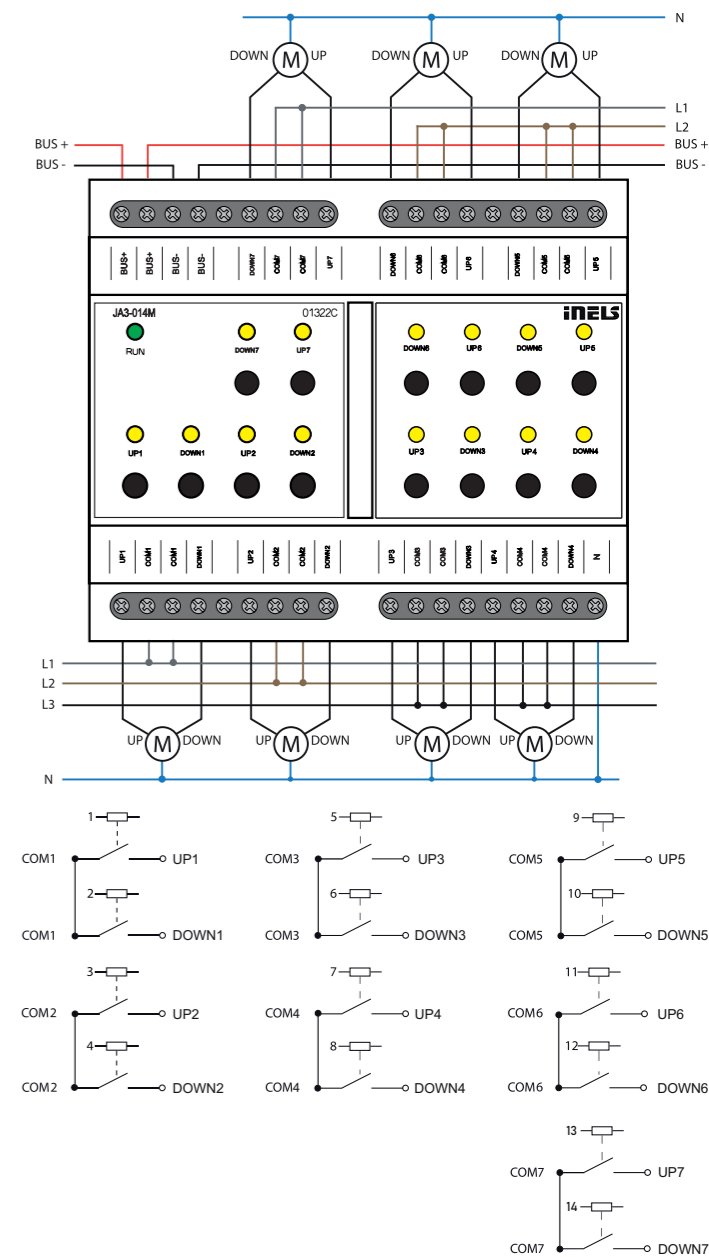

Note:
For the protection of relay it is recommended to use protection device: 10A (maximum output) B class circuit breaker.



EAN code
JA3-014M/E: 8595188189491
Order Code: 8949

Technical parameters	JA3-014M/E
Outputs	
Output:	14x switching 0.5 A/AC15
Switched voltage:	250 V AC, 30 V DC
Switched output:	125 VA/AC15
Protection:	10A (maximum output) B class circuit breaker
Peak current:	10 A
Output relays separated from all internal circuits:	reinforced insulation (Cat. II surges by EN 60664-1)
Isolation between relay outputs COM 1,2 COM 3,4 COM 5,6 COM 7,8 COM 9,10 COM 11,12:	reinforced insulation (Cat. II surges by EN 60664-1)
Isolates. voltage open relay contact:	1 kV
Max. current of one common terminal:	12 A
Minimal switched current:	100 mA/10 V DC
Switching frequency without load:	300 min ⁻¹
Switching frequency with rated load:	15 min ⁻¹
Mechanical life:	1x 10 ⁷
Electrical life AC1:	1x 10 ³
Mains voltage detection:	yes (relay switching in zero)
Output indication:	-
Control:	-
Communication	
Installation BUS:	BUS
Status indication unit:	green LED RUN
Power supply	
Voltage of BUS/tolerance/nominal current:	27 V DC, -20/+10 %, 150 mA
Connection	
Terminal:	max. 2.5 mm ² /1.5 mm ² with sleeve
Operating conditions	
Operating temperature:	-20 to +55 °C
Storing temperature:	-30 to +70 °C
Protection degree:	IP20 device, IP40 mounting in the switchboard
Overtoltage category:	II.
Pollution degree:	2
Operating position:	any
Installation:	switchboard on DIN rail EN 60715
Design:	6-MODULE
Dimensions and weight	
Dimensions:	90 x 105 x 65 mm
Weight:	310 g
Standards:	EN 63044-1

- JA3-014M/E is an actuator designed for controlling rollers, shutters, blinds, awnings, garage doors, entrance gates, etc.
- It controls electric drives that are controlled in two directions and have a built-in limit switch.
- The unit's status is indicated by the green RUN LED on the front panel
 - if the BUS voltage is connected, but there is no communication via BUS with master, the LED RUN is on continuously.
 - if the bus voltage is connected and the unit communicates by BUS, the LED RUN flashes.
- The software blocking of output relay contacts can be secure using the iNELS Design Manager software.
- JA3-014M/E is normally supplied in the option AgSnO2 contact material.
- JA3-014M/E in 6-MODULE version is designed for mounting into a switchboard on DIN rail EN60715.
- JA3-014M/E is an economic option without manual control buttons on the front panel and status LEDs for the relay output. (possibility to control via iDM software).
- The unit has synchronized closing and opening of the relay in the zero voltage of the sinusoidal waveform. The sync inputs are COM 1, 2, 3, 4, 5, 6 and 7 against the N terminal.

Connection

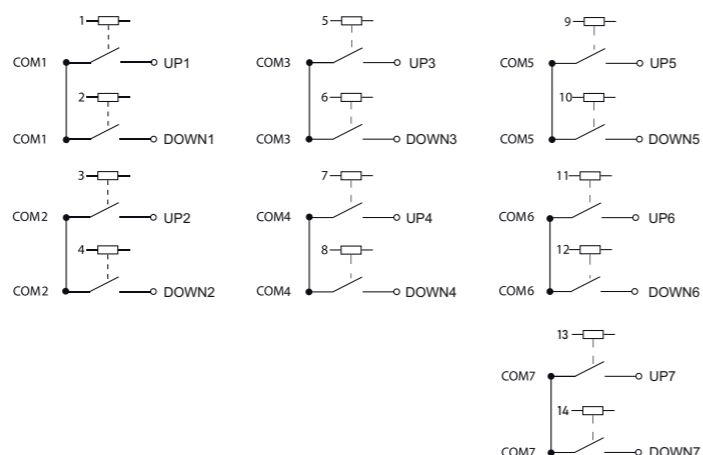
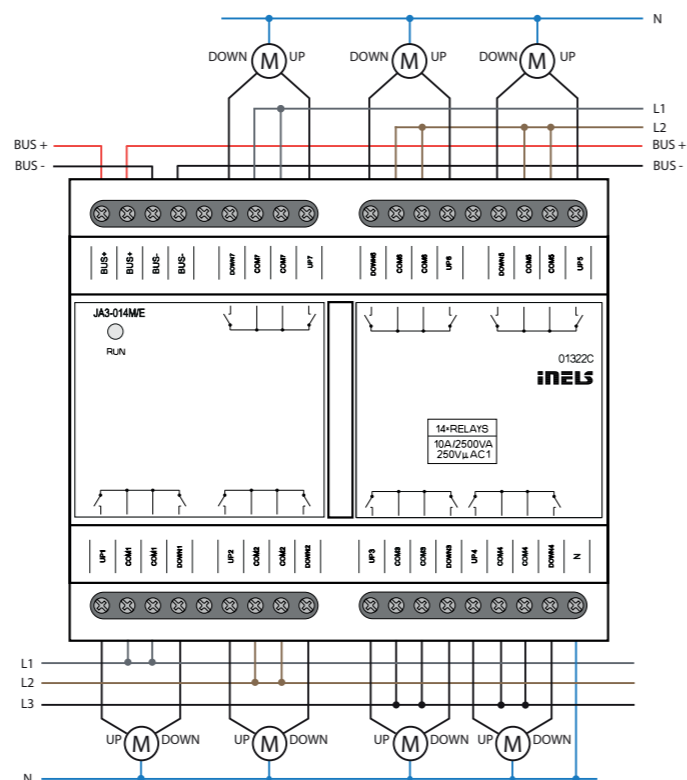

Note:
For the protection of relay it is recommended to use protection device: 10A (maximum output) B class circuit breaker.



EAN code
DA3-22M: 8595188132626
DA3-22M/120V: 8595188133036
Order Code:
DA3-22M: 3262
DA3-22M/120V: 3303

Technical parameters	DA3-22M	DA3-22M/120V
Inputs		
Input:	2x inputs, switching potential L*	
Temperature measuring:	YES, input for external thermo sensor TC/TZ	
Scope and accuracy of temp. measurement:	-20 to +120 °C; 0.5 °C from the range	
Number of control buttons:	2x buttons 4x potentiometers on front panel	
Outputs		
Output:	2x contactless outputs, 2x MOSFET	
Load type:	resistive, inductive, capacitive**, LED, ESL	
Isolation BUS separated from all internal circuits:	reinforced insulation (Cat. II surges by EN 60664-1)	
Isolation voltage between particular power:	max. 500 V AC	
Minimal controlled load:	10 VA	
Maximal controlled load:	400 VA for each channel	200 VA for each channel
Output indication ON/OFF:	2x yellow LED	
Device protection:	thermal/short-term overload/ long-term overload	
Communication		
Installation BUS:	BUS	
Power supply		
Supply voltage by BUS/tolerance:	27 V DC, -20/+10 %	
Rated current:	5 mA (at 27 V DC), from BUS	
Status indication unit:	green LED RUN	
Supply voltage for power section/tolerance:	AC 230 V (50 Hz), -15/+10 %	AC 120 V (60 Hz), -15/+10 %
Dissipated power:	max. 13 W	max. 7.5 W
Connection		
Terminal:	max. 2.5 mm ² /1.5 mm ² with sleeve	
Operating conditions		
Air humidity:	max. 80 %	
Operating temperature:	-20 to +35 °C	
Storing temperature:	-30 to +70 °C	
Protection degree:	IP20 device, IP40 mounting in the switchboard	
Overtoltage category:	II.	
Pollution degree:	2	
Operating position:	vertical	
Installation:	switchboard on DIN rail EN 60715	
Design:	3-MODULE	
Dimensions and weight		
Dimensions:	90 x 52 x 65 mm	
Weight:	170 g	
Standards:	EN 63044-1	

* The inputs are not galvanically isolated from the supply voltage.
** **Attention:** It is not allowed to connect loads of inductive and capacitive character, at the same time.
⚠ Input is connected to the mains voltage potential.

- DA3-22M is a universal dimming 2-fold actuator enabling control of brightness intensity of dimmable light sources of the type ESL, LED and RLC with power supply 230 V.
- DA3-22M has two MOSFET controlled outputs 230 V AC, maximum load is 2x 400 VA.
- Option of connecting an external temperature sensor.
- Each output channel is independently controllable and addressable.
- Type of light source is set by a switch on the front panel.
- By setting the min. brightness potentiometer on the front panel, flashing of different types of light sources is eliminated.
- DA3-22M is equipped with two inputs 230 V AC, which can be controlled by mechanical switches (buttons, relays). Inputs are galvanically connected to potential L, which is permanently at the terminals IN1 and IN2.
- By clicking on buttons on the front panel you can manually switch on or off the corresponding output.
- Electronic overcurrent and thermal protection - switch off output in case of overload short circuit and overheating.
- The power supply (potential L) must be protected by a protective element corresponding to the power input of the connected load, e.g. a safety fuse.
- During installation, it is necessary to leave on each side of the actuator at least half the module space for better cooling.
- DA3-22M in 3-MODULE version is designed for mounting into a switchboard on DIN rail EN60715.

Connection

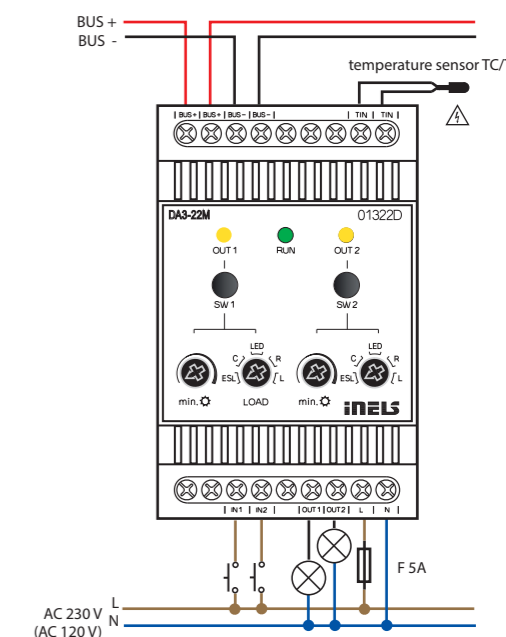

Types of connectable loads

type of source	symbol	description
R resistive		ordinary light bulb, halogen lamp
L inductive		coiled transformer for low-voltage halogen lamps
C capacitive		electronic transformer for low-voltage halogen lamps
LED		LED lamps and LED light sources, 230 V
ESL		dimmable energy-saving fluorescent tubes



EAN code
DA3-66M /230: 8595188182065
DA3-66M /120: 8595188174459
Order Code:
DA3-66M /230: 8206
DA3-66M /120: 7445

Technical parameters DA3-66M/230V DA3-66M/120V

Outputs	
Output:	6x contactless outputs, 2x MOSFET / channel
Load type: *	R-resistive, L-inductive, C-capacitive, LED, ESL - economical
Minimal controlled load:	10 VA
Maximal controlled load:	DA3-66M / 230V: 150 VA for each channel DA3-66M / 120V: 75 VA for each channel possibility of parallel connection of outputs
Output indication ON/OFF:	6x yellow LED
Device protection:	thermal/short-term overload/ long-term overload

Inputs	
Wire buttons:	6x galvanically separated
Input voltage:	20-230 AC(50-60 Hz)/DC
Isolation voltage:	between inputs max. 230 VAC/DC (basic insulation) to all other internal circuits: reinforced insulation: overvoltage category II
Maximum cable length:	10 m
Glow plug connection:	no

Communication	
Installation BUS:	BUS

Power supply	
Supply voltage by BUS/ tolerance:	27 V DC, -20/+10 %
Rated current:	100 mA (at 27 V DC), from BUS
Status indication unit:	green LED RUN
Supply voltage for power section/tolerance:	AC 230 V (50-60 Hz), -15/+10 % AC 120 V (50-60 Hz), -15/+10 %

Connection	
Terminal:	max. 2.5 mm ² /1.5 mm ² with sleeve

Operating conditions	
Air humidity:	max. 80 %
Operating temperature:	-20 to +50 °C
Storing temperature:	-30 to +70 °C
Protection degree:	IP20 device, IP40 mounting in the switchboard
Overvoltage category:	II.
Pollution degree:	2
Operating position:	vertical
Installation:	switchboard on DIN rail EN 60715
Design:	6-MODULE

Dimensions and weight	
Dimensions:	90 x 105 x 65 mm
Weight:	320 g
Standards:	EN 63044-1

- DA3-66M is a universal dimming 6-channels actuator, which is used to control the brightness of dimmable light sources such as ESL, LED and RLC with 230 V power supply.
- The DA3-66M has 6 semiconductor controlled 230 V AC outputs. The maximum possible load is 150 VA for each channel.
- The individual outputs of the dimmer can be connected in parallel and thus increase the maximum output load at the expense of the number of outputs.
- Each output channel is independently controllable and addressable.
- By setting min. brightness, the flickering of different types of light sources is eliminated.
- Min. brightness and type of load is performed using SW IDM.
- Use the control buttons on the front panel to manually control the output.
- The actuator is equipped with electronic overcurrent and thermal protection, which switches off the output in case of overload, short circuit, overheating.
- The dimmer has 6 galvanically separated inputs which can be used both to control the dimmer and as a binary input to the iNELS system.
- The the device supply (potential L) must be protected with a safety device corresponding to the power input of the connected load, e.g. with a quick-release fuse.
- During installation, it is necessary to leave at least half a module of free space on each side of the actuator for better cooling.
- DA3-66M is in 6-MODULE version and is intended for mounting in a switchboard on DIN rail EN60715.

Connection

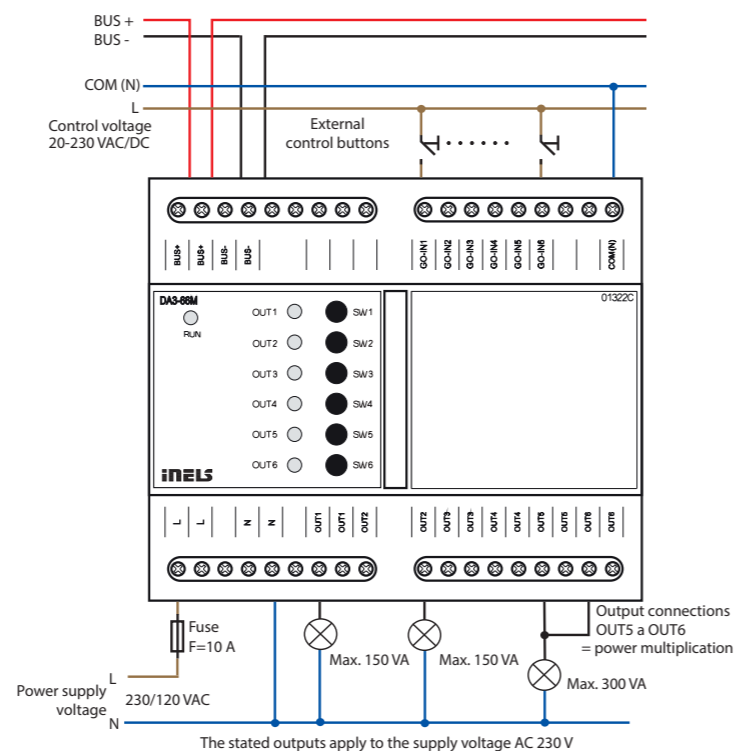

Types of connectable loads

type of source	symbol	description
R resistive		ordinary light bulb, halogen lamp
L inductive		coiled transformer for low-voltage halogen lamps
C capacitive		electronic transformer for low-voltage halogen lamps
LED		LED lamps and LED light sources, 230 V
ESL		dimmable energy-saving fluorescent tubes

* **Attention:** It is not allowed to connect loads of inductive and capacitive character, at the same time.



EAN code
DA3-03/RGBW: 8595188184632
Order Code: 8463

Technical parameters DA3-03M/RGBW

Output	
Dimmable load:	LED strip 12 V, 24 V, 48 V; RGBW LED strip 12 V, 24 V, 48 V
Number of channels:	3x 4 12x 1
Surge current:	3x 15 A 12x 3,75 A
Switching voltage:	0-50 V DC stabilized
Dimmable performance:	max. 400 W

Communication	
Installation BUS:	BUS

Power supply	
Supply voltage by BUS/ tolerance:	27 V DC, -20/+10 %
Rated current:	5 mA (from 27 V DC), from BUS
Status indication unit:	green LED RUN

Connection	
Terminal:	max. 2.5 mm ² /1.5 mm ² with sleeve

Operating conditions	
Air humidity:	max. 80 %
Operating temperature:	-20 to +35 °C
Storing temperature:	-30 to +70 °C
Protection degree:	IP20 device, IP40 mounting in the switchboard
Pollution degree:	2
Operating position:	vertical
Installation:	switchboard on DIN rail EN 60715
Design:	3-MODULE

Dimensions and weight	
Dimensions:	90 x 52 x 65 mm
Weight:	170 g
Standards:	EN 63044-1

- The dimmer for LED strips is used for independent control of 12 channels, so it can be connected to, for example:
3 RGBW led strips or 3 RGB led strips
12 single colour LED strips
combination of RGB, RGBW & LED strips
- The 3-module design of the device with mounting in the switchboard allows the connection of a dimmable load of 3x 15 A or 12x 3.75 A, which represents, for example: 3 pieces of RGBW LED strips 24 V 20W/m = max 18m.
- The dimmer is controlled by the central unit of the iNELS system.
- The power supply of the LED strip is in the range of 0-50V DC.
- Each of the output channels is separately controllable and addressable.
- The actuator is equipped with electronic thermal protection, which switches off the output in case of overheating.
- During installation, it is necessary to leave at least half a module of free space on each side of the actuator for better cooling.
- DA3-03M/RGBW in 3-MODUL design is intended for installation in a switchboard on an EN60715 DIN rail.

Connection

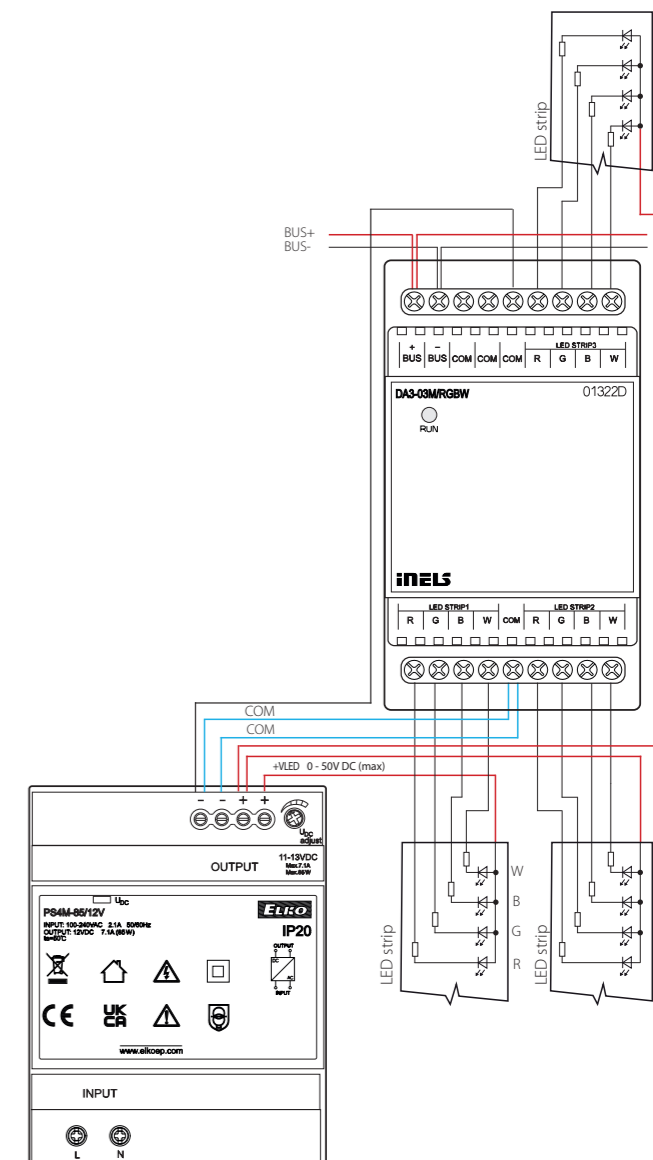

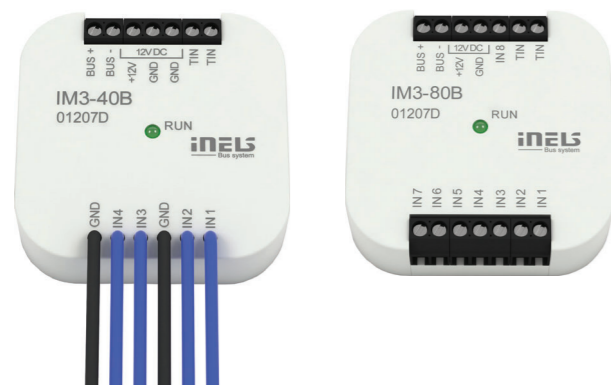

EAN code: IM3-40B: 8595188132312
 Order Code: IM3-40B: 3231
 IM3-80B: 8595188132329
 Order Code: IM3-80B: 3232

Technical parameters	IM3-40B	IM3-80B
Inputs		
Input:	4x* IN1, IN2**	8x* IN1 - IN5**
Max. frequency pulse reading:	20 Hz	
Temperature measuring:	yes, input for external thermo sensor TC/TZ	
Range/accuracy of thermomeasuring:	-20 to +120 °C/0.5 °C from the range	
Outputs		
Output voltage/current:	12 V DC/75 mA, for supplying EZS sensors	
Communication		
Installation BUS:	BUS	
Status indication unit:	green LED RUN	
Power supply		
Supply voltage/tolerance:	27 V DC, -20/+10 %	
Dissipated power:	max. 1 W	
Rated current:	20 mA (at 27 V DC), from BUS	
Rated current of unit for full load on output 12 V DC:	60 mA	100 mA
Connection		
Terminal:	0.5-1 mm ²	
Inputs:	6x conductors CY length 90 mm	x
Operating conditions		
Operating temperature:	-20 to +55 °C	
Storing temperature:	-30 to +70 °C	
Protection degree:	IP30	
Overvoltage category:	II.	
Pollution degree:	2	
Operating position:	any	
Installation:	into installation box	
Dimensions and weight		
Dimensions:	49 x 49 x 13 mm	
Weight:	32 g	27 g
Standards:	EN 63044-1	

* NO or NC against GND(-)
 ** are balanced inputs

Balanced input

Simple:

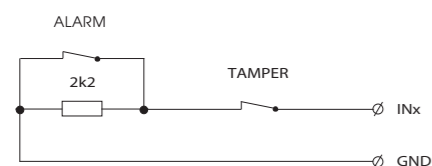

Double:

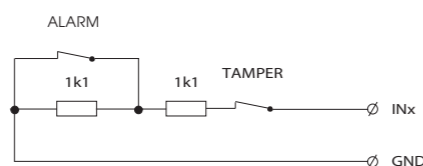

- Binary input units IM3-40B and IM3-80B are used for connection of 4 or 8 devices with potential-less contacts (switches, buttons, switches of other design, PIR detectors, fire and gas detectors, etc.).
- Part of the inputs can be used as a balanced for alarm detectors:
 - IM3-40B – inputs IN1, IN2
 - IM3-80B – inputs IN1 – IN5
- Contacts of external devices connected to the inputs of the unit can be NO or NC - input parameters are configured in the software iDM3.
- Within the internal ESS configured in the iDM3 software, inputs must be set to balance or double balance.
- The units generate a supply voltage of 12 V DC/75 mA for powering external intrusion detectors, so they can power PIR detectors, fire and gas detectors.
- Active use 12 V DC output for powering detectors increases the nominal consumption of units from BUS (see technical data).
- The units can be used for counting pulses of energy meters with pulse output.
- The units are equipped with a temperature input for connecting an external two-wire temperature sensor TC/TZ (see accessories).
- IM3-40B, IM3-80B in case type B are designed for mounting into a installation box.

Connection

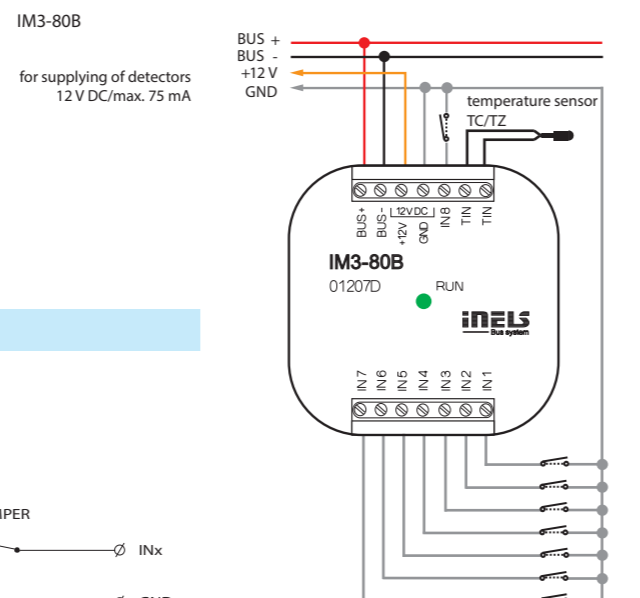
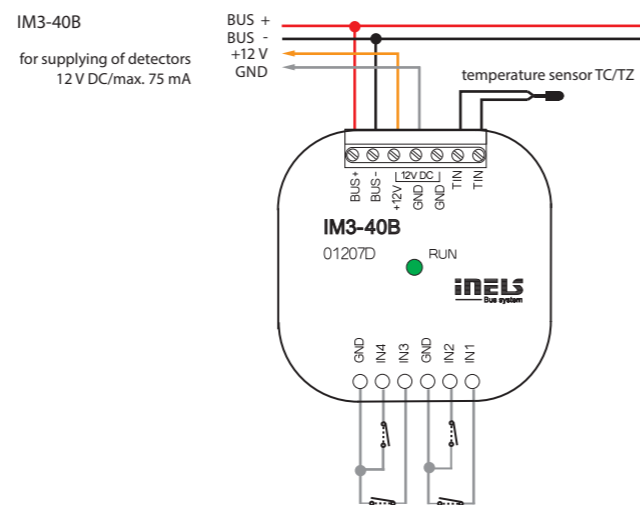

EAN code: IM3-140M: 8595188132459
 Order Code: 3245

Technical parameters	IM3-140M
Inputs	
Input:	14x NO or NC against GND (-) IN1 - IN7 - are balanced inputs
Max. frequency pulse reading:	20 Hz
Outputs	
Output (power supply 12 V for sensors):	12 V DC/150 mA
Communication	
Installation BUS:	BUS
Data transfer indication:	green LED
Power supply	
Supply voltage/tolerance:	27 V DC, -20/+10 %
Dissipated power:	max. 1 W
Rated current:	25 mA (at 27 V DC), from BUS
Rated current for full load on output 12 V DC:	100 mA
Connection	
Terminal:	max. 2.5 mm ² /1.5 mm ² with sleeve
Operating conditions	
Air humidity:	max. 80 %
Operating temperature:	-20 to +55 °C
Storing temperature:	-30 to +70 °C
Protection degree:	IP20 device, IP40 mounting in the switchboard
Overvoltage category:	II.
Pollution degree:	2
Operating position:	any
Installation:	into a switchboard rail to DIN EN 60715
Design:	3-MODULE
Dimensions and weight	
Dimensions:	90 x 52 x 65 mm
Weight:	104 g
Standards:	EN 63044-1

Balanced input

Simple:

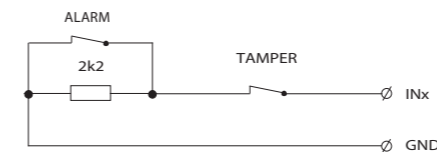

Double:

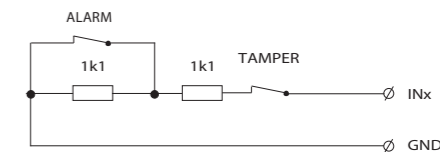

- Binary input unit IM3-140M is designed to connect up to 14 devices with potentialless contact (such as switches, buttons of other designs, fire and glass detectors and others).
- Inputs IN1 - IN7 can be balanced.
- Contacts of external devices connected to the inputs of the drive can be NO or NC - Input parameters are configured in the software iDM3.
- Inputs must be configured as balanced or double balanced - in an internal Electronic security system configured in iDM3 software.
- The unit generates a supply voltage of 12 V DC/150 mA for powering external detectors, so it can power PIR detectors, fire and gas detectors.
- Active use 12 V DC output for powering detectors increases the nominal consumption units from BUS (see technical data).
- The unit can be used for counting pulses of energy meters with pulse output.
- IM3-140M in 3-MODULE is designed for switchboard mounting on DIN rail EN60715.

Connection

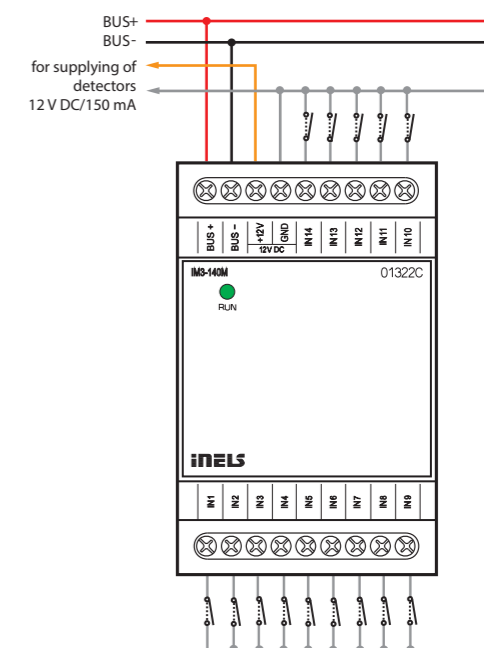



EAN code
T13-40B: 8595188132695
Order Code: 3269

Technical parameters T13-40B

Input	
Temperature input for temperature measuring:	4x inputs for external thermo sensor*
Temperature measurement range:	by type of sensor, prob from -50°C to 400°C
Converter resolution:	15 bit
Communication	
Installation BUS:	BUS
Status indication unit:	green LED RUN
Power supply	
Supply voltage/tolerance:	27 V DC, -20/+10 %
Dissipated power:	max. 1 W
Rated current:	20 mA (at 27 V DC), from BUS
Connection	
Terminal:	0.5 mm ² - 1 mm ²
Operating conditions	
Operating temperature:	-20 to +55 °C
Storing temperature:	-30 to +70 °C
Protection degree:	IP30
Overtoltage category:	II.
Pollution degree:	2
Operating position:	any
Installation:	into installation box
Dimensions and weight	
Dimensions:	49 x 49 x 13 mm
Weight:	27 g
Standards:	EN 63044-1

*TC, TZ, Ni1000, Pt1000, Pt100, see accessories

Connection options

2-wire
- it is necessary to connect terminals TIN_B and COM

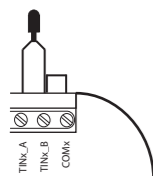

3-wire
- connection of the sensor needs to be done according to the technical specifications

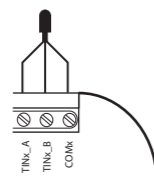

- The unit is designed for connection of up to four (T13-40B) external temperature sensors.
- Units range T13 support the connection of the following temperature sensors:
 - TC/TZ - 2-wire connections
 - Ni1000, Pt1000, Pt100 - 2-wire and 3-wire connections
- Used in when necessary to take temperatures from different places (for example large floor heating – diagonal layout of sensors, floor/ space, indoor/outdoor temperature, technological device – boiler, solar heating etc.)
- Status of units indicated by green RUN LED on the front panel:
 - if the supply voltage is connected (units are powered via the BUS), but there is no communication with the master, RUN LED is lit continuously.
 - if the supply voltage is connected and the unit communicates via standard BUS, RUN LED flashes.
- T13-40B in version B is designed for mounting into an installation box.

Connection

T13-40B

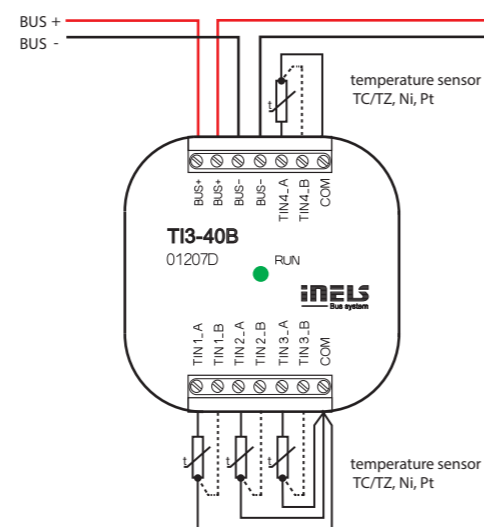

EAN code
T13-60M: 8595188132893
Order Code: 3289

Technical parameters T13-60M

Input	
Temperature input for temperature measuring:	6x input for external temperature sensor TC, TZ, Ni1000, Pt1000, Pt100 see accessories
Temperature measurement range:	by type of sensor, probe from -50°C to 400°C
Converter resolution:	15 bit
Indication of exceeding the range or interruption of the sensor:	6x red LED
Communication	
Installation BUS:	BUS
Status indication unit:	green LED RUN
Power supply	
Supply voltage/tolerance:	27 V DC, -20/+10 %
Dissipated power:	max. 1 W
Rated current:	45 mA (at 27 V DC), from BUS
Connection	
Terminal:	max. 2.5 mm ² /1.5 mm ² with sleeve
Operating conditions	
Operating temperature:	-20 to +55 °C
Storing temperature:	-30 to +70 °C
Protection degree:	IP20 device, IP40 mounting in the switchboard
Overtoltage category:	II.
Pollution degree:	2
Operating position:	any
Installation:	into a switchboard rail to DIN EN 60715
Design:	3-MODULE
Dimensions and weight	
Dimensions:	90 x 52 x 65 mm
Weight:	111 g
Standards:	EN 63044-1

Connection options

2-wire
- it is necessary to connect terminals TIN_B and COM



3-wire
- connection of the sensor needs to be done according to the technical specifications



- Unit T13-60M is designed to connect up to six external temperature sensors.
- Units range T13 support the connection of the following temperature sensors:
 - TC/TZ - 2-wire connections
 - Ni1000, Pt1000, Pt100 - 2-wire and 3-wire connections
- It is used in cases where it is necessary to read the temperature, eg floor/ room, indoor/outdoor temperature, process equipment - boiler, solar heating, etc.
- Unit status is indicated by green RUN LED on the front panel:
 - if the supply voltage is connected (the unit is powered via the BUS), but there is no communication with the master, RUN LED is lit continuously.
 - if the supply voltage is connected and the unit communicates via standard BUS, RUN LED flashes.
- The status on individual temperature inputs is indicated by the relevant red LED on the front panel:
 - LIT - temperature sensor disconnection
 - FLASHES - exceeding of the temperature range
 - UNLIT - ok
- T13-60M in 3-MODULE is designed for switchboard mounting on DIN rail EN60715.

Connection

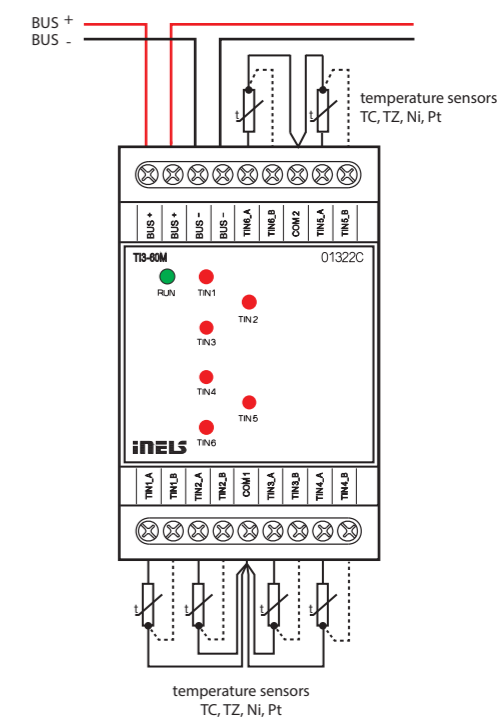

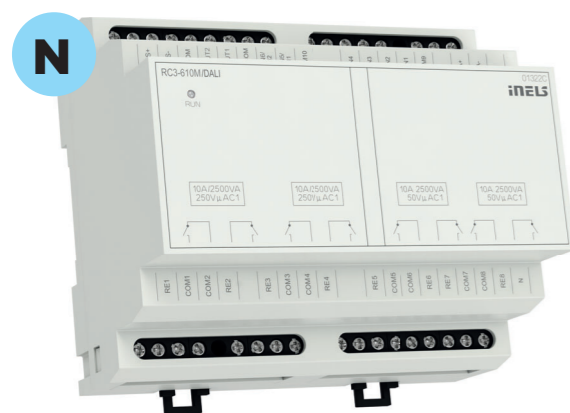

EAN code
RC3-610M/DALI: 8595188184663
Order Code: 8466

Technical parameters		RC3-610M/DALI
Output		
Relay	8x NO/switch 10 A/AC1	
Switched voltage:	250VAC, 30VDC	
Switched power:	2500 VA/AC1, 150 W/DC	
Peak current:	10A AC1, 5A DC	
Relay outputs separated from all internal circuits:	reinforced insulation (Overvoltage cat. II according to EN 60664-1)	
Isolation between COM1,2 a COM3,4 a COM5,6,7,8*	basic insulation (cat. overvoltage II according to EN 60664-1) max. 400AC	
Isolation voltage of the open relay contact:	1 kV	
Max. current through one common terminal:	16 A	
Minimum switching current:	100 mA/10 V DC	
Mechanical service life:	10 000 000	
Electrical life AC1:	100 000	
Analog		
Analog outputs:	AO1, AO2	
Voltage analogue. output/ max. current:	2x 0(1) - 10 V/10 mA	
Inputs		
Input DIN:	6x DIN (digital input) or 4x DIN + 2x TIN (temperature input) **	
DIN sampling rate:	20 Hz	
DIN common wire:	COM9, COM10	
TIN common wire:	TINCOM	
Communication		
DALI		
Output interface:	DALI	
DALI addresses (max.):	16	
Internal DALI source:	yes, max. 64 mA	
BUS		
Installation bus:	BUS	
Indication of unit status:	Green LED RUN	
Power		
Internal DALI supply terminals:	terminals COM8 and N	
Internal DALI supply voltage:	100-240V 50/60Hz max.0.1A	
Power dissipation:	3 W	
Connection		
Terminal plate:	max. 2.5 mm ² /1.5 mm ² with core	

* adjacent COM terminals (COM1 and 2, COM3 and 4, COM5 and 6, COM7 and 8) must be at the same potential

** input function is set during configuration

*** ACOM and COM9 terminals are at BUS potential

To provide power to the Dali bus via DA+ and DA-, it is essential to establish a 230V connection between Com8 and N.

- The RC3-610M/DALI is an I/O actuator equipped with 6 binary inputs, of which 2 can be configured as temperature inputs and 8 independent relays with switching potential-free and potential contacts. It also includes two analog outputs 0(1)-10 V with a load capacity of up to 10 mA.
- Binary inputs RC3-610M/DALI are used for connecting up to 6 devices with a non-decimal contact (such as switches, buttons of other designu, EZS and EPS detectors and others).
- Temperature inputs support the connection of TC/TZ temperature sensors in a 2-wire connection for temprature sensing needs.
- The actuator is designed for switching up to eight different appliances and loads by relay output (potential-free contact).
- The maximum load capacity of the relay contacts is 10 A/2500 VA/ AC1. Each of the output contacts is individually controllable. Relays are divided into four pairs, where each pair switches on its common potential.
- The DALI system BUS allows control of up to 16 independent DALI (Digital Addressable Lighting Interface) ballast addresses for fluorescent, LED and other luminaires.
- Analog outputs are considered for use with thermoregulation heads, air-conditioning ventilation flaps, various other dimmers or other devices with an analog control voltage of 0-10 V or 1-10 V.
- The parameters of all configurable inputs and outputs are set in the iNELS Designer & Manager configuration software environment, which is designed for Windows 7, 8 and 10 operating systems.
- RC3-610M/DALI in 6-MODULE version is designed for mounting into a switchboard on DIN rail EN60715.

Operating conditions

Working temperature:	-20 to +55 °C
Storage temperature:	-30 to +70 °C
Degree of protection:	IP20 device, IP40 with cover in the control cabinet
Surge category:	II.
Degree of pollution:	2
Working position:	any
Installation:	to the control cabinet for DIN rail EN 60715
Design:	6-MODULE

Dimensions and weight

Dimensions:	90 x 105 x 65 mm
Weight:	310 g
Standards:	EN 63044-1

Connection

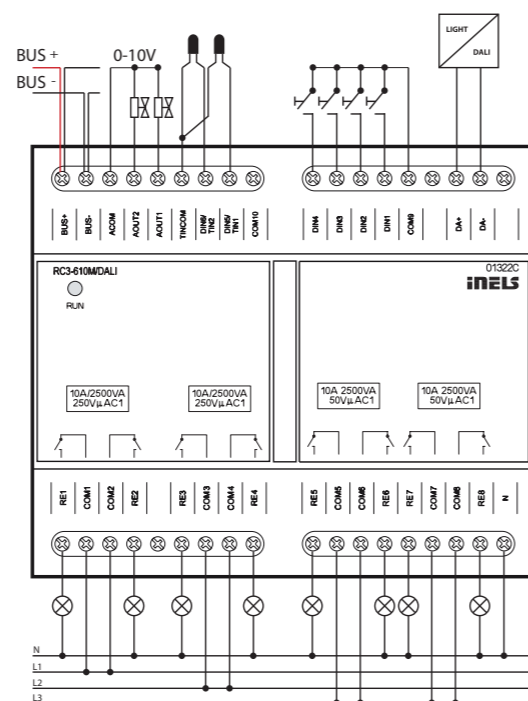

EAN code
FA3-612M: 8595188135276
Order Code: 3257

Technical parameters		FA3-612M
Input		
Analog inputs:	3x voltage, current or temperature input	
Number of inputs:	3	
Galv. separation from inner circuits:	no	
Diagnostic:	indication red LED OVERRANGE (exceeding the range, interruption of a sensor or overload of Uref output)	
Common terminal:	GND	
Converter resolution:	14 bits	
Input resistance		
- for voltage ranges:	approx. 150 kΩ	
- for current ranges:	100 Ω	
Types of inputs/measuring ranges*:	Voltage (U): 0 ÷ +10 V (U) ; 0 ÷ +2 V (U) Current (I): 0 ÷ +20 mA (I) ; 4 ÷ +20 mA (I) temperature: input at ext. temperature sensor TC, TZ, Ni1000**, Pt1000**, Pt100** see accessories/ according to used sensor from -30 °C to 250 °C	
Digital inputs:		
Input voltage:	20 - 240 V AC (50 - 60 Hz)/DC	
Galv. separation from internal circuits:	yes	
Common lead:	GO COM3	
Outputs		
Analog:	4x (A_OUT1 - A_OUT4)	
Voltage analog. output/max. current:	4x 0(1) - 10 V/10 mA	
Uref reference voltage outputs		
Voltage/Current Uref:	10 V DC/100 mA	
Output overload indication:	red LED OVERLOAD	
SSR (Electronic Relay):		
Switching voltage:	20 - 240 V AC	
Switching capacity:	480 VA	
Peak current:	20 A, t ≤ 16 ms	
Output indication:	yellow LED	
Relay 6A:		
Switching voltage:	250 V AC, 24 V DC	
Switching capacity:	1500 VA/AC1; 300 VA/AC15; 180 W/DC, AC3	
Relay outputs separated from all internal circuits:	reinforced insulation (Cat. II surges by EN 60664-1)	
Minimum switching load:	500 mW (12 V/10 mA)	
Mechanical life:	10x10 ⁶	
Electrical life AC1:	6x10 ⁴	
Output indication:	yellow LED	
Communication		
Installation BUS:	BUS	
Status indication unit:	green LED RUN	
Power supply		
Supply voltage/tolerance/ rated current:	27 V DC, -20/+10 %, 5 mA	
Supply voltage of power section (relay) tolerance/ nominal current:	AC 230 V (50 Hz), -15/+10 %, 20 mA	
Dissipated power:	max. 1 W	

- FA3-612M is a unit (actuator) designed to control fancoil units using analogue/digital inputs and analog/relay outputs.
- Analog inputs for temperature, voltage or current measurement (Uref reference voltage can also be used).
- The digital inputs are galvanically isolated with positive logic (Sink) in the 24-230 V AC/DC voltage range.
- Analog outputs 0-10 V.
- Connection to the installation BUS.
- Buttons for closing/opening the valve, fan and heating relay.
- The LEDs on the front panel indicate FAN, RE, VALVE1, VALVE2, OVER-RANGE, and OVERLOAD status.
- FA3-612M in 6-MODULE version is designed for mounting into a switchboard, on DIN rail EN60715.

Connection

Terminal:	max. 2.5 mm ² /1.5 mm ² with sleeve
Operating conditions	
Operating temperature:	-20 to +55 °C
Storing temperature:	-30 to +70 °C
Protection degree:	IP20 device, IP40 mounting in the switchboard
Overvoltage category:	II.
Pollution degree:	2
Operating position:	any
Installation:	switchboard on DIN rail EN 60715
Design:	6-MODULE
Dimensions and weight	
Dimensions:	90 x 105 x 65 mm
Weight:	307 g
Standards:	EN 63044-1

Connection

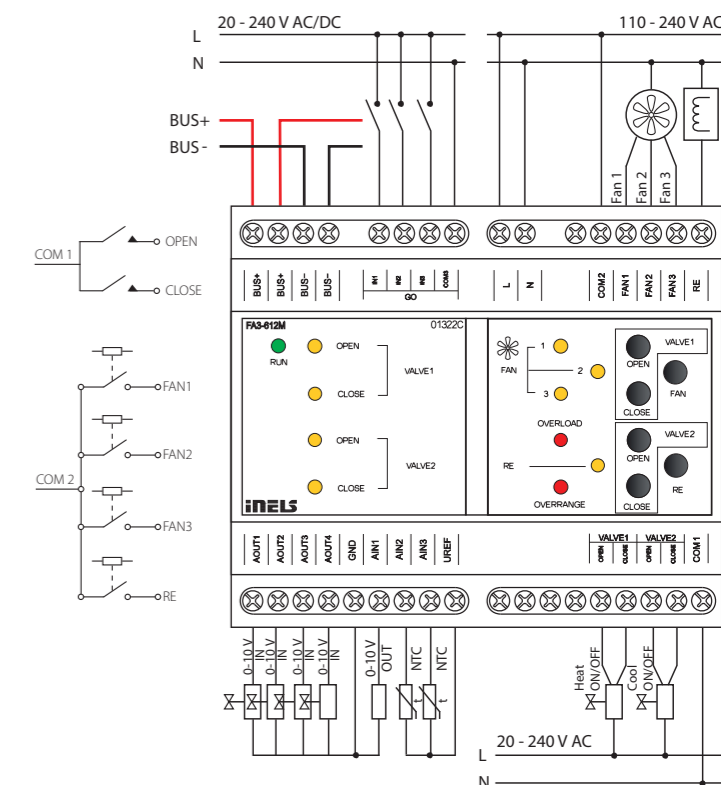

* selectable for each input individually by configuration in the user program iDM3.
** The FA3-612M / Pt version is available for these sensors.

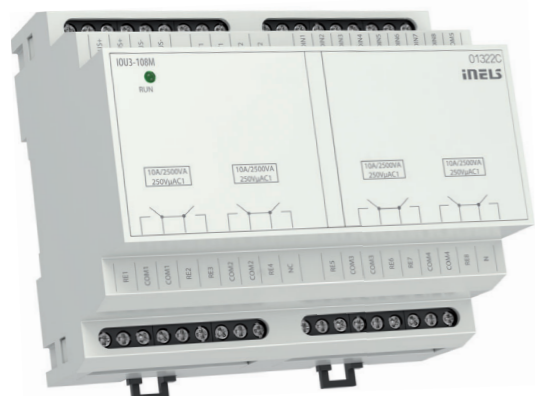

EAN code
IOU3-108M: 8595188181884
Order Code: 8188

Technical parameters	IOU3-108M
Outputs	
Output:	8x switching 8 A/AC1
Switched voltage:	250 V AC1, 150 W/DC
Switched output:	2500 VA/AC1, 150 W/DC
Peak current:	10 A
Output relays separated from all internal circuits:	reinforced insulation (Cat. II surges by EN 60664-1)
Isolation between relay outputs COM1, COM2 and COM3:	basic insulation (Cat. II surges by EN 60664-1)
Isolates. voltage open relay contact:	1 kV
Max. current of one common terminal:	16 A
Minimal switched current:	100 mA/10 V DC
Switching frequency without load:	300 min ⁻¹
Switching frequency with rated load:	15 min ⁻¹
Mechanical life:	10 000 000
Electrical life AC1:	100 000
Mains voltage detection:	yes - (relay switched to neutral)
Inputs	
Input:	8x NO or NC against GND (-)
Max. frequency pulse reading:	20 Hz
Temperature input for temperature measuring:	2x input for external thermo sensor TC, TZ (NTC 12k)
Temperature measurement range:	by type of sensor, prob from -40 °C to 125 °C
Converter resolution:	15 bit
Communication	
Installation BUS:	BUS
Status indication unit:	green LED RUN
Power supply	
Voltage of BUS/tolerance/nominal current:	27 V DC, -20/+10 %, 110 mA
Dissipated power:	3 W
Connection	
Terminal:	max. 2.5 mm ² /1.5 mm ² with sleeve
Operating conditions	
Operating temperature:	-20 to +55 °C
Storing temperature:	-30 to +70 °C
Protection degree:	IP20 device, IP40 mounting in the switchboard
Overvoltage category:	II.
Pollution degree:	2
Operating position:	any
Installation:	switchboard on DIN rail EN 60715
Design:	6-MODULE
Dimensions and weight	
Dimensions:	90 x 105 x 65 mm
Weight:	310 g
Standards:	EN 63044-1

- IOU3-108M is combined actuator equipped with 8 binary inputs, 2 temperature inputs and 8 independent relays with switching potential-free contacts.
- Binary inputs IOU3-108M are used to connect up to 8 devices with a potential-free contact (such as switches, buttons, burglar alarm and fire detectors or others).
- The unit can be used to read pulses from energy meters with a pulse output.
- The temperature inputs support the connection of the following temperature sensors: TC / TZ - 2-wire connection.
- They are used in cases where it is necessary to measure the temperature, eg floor/space, indoor/outdoor temperature, technological equipment - boiler rooms, solar heating, etc.
- The maximum load capacity of the contacts is 10 A / 2500 VA / AC1.
- Each of the output is individually controllable and addressable.
- The relays are divided into four pairs, where each pair switches its common potential.
- The actuator is designed for switching up to eight different appliances and loads via a relay output (potential-free contact).
- IOU3-108M in 6-MODULE design is designed for mounting in a switchboard on DIN rail EN60715.

Connection

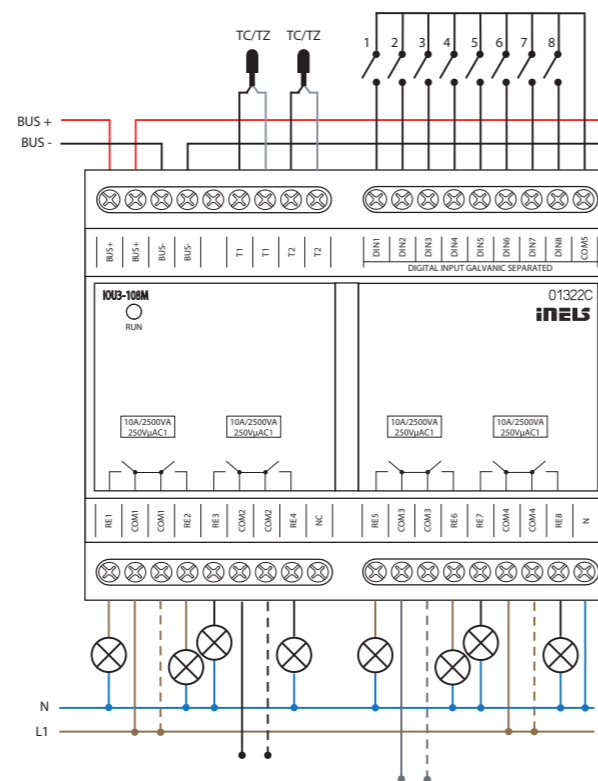

Diagram

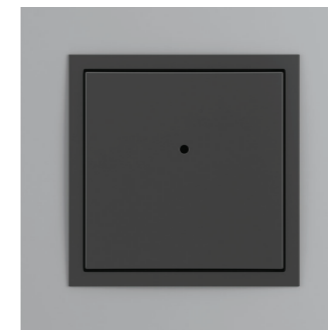
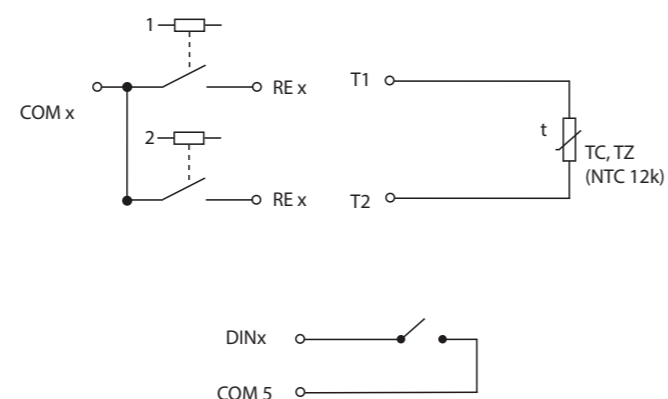

EAN code
WSB3-20: 8595188132343
WSB3-20H: 8595188132473

Order Code:
WSB3-20: 3234
WSB3-20H: 3247

Technical parameters	WSB3-20	WSB3-20H
Inputs		
Temperature measuring:	yes, built-in temperature sensor	
Scope and accuracy of temp. measuring:	0 to +55 °C ; 0.3 °C from the range	
Number of control buttons:	2	
Humidity measurement:	NO	YES
Humidity measurement range:	-	0 to 99 % Relative humidity
Humidity measurement accuracy:	-	± 3 % Relative humidity
Inputs:	2x AIN/DIN	
External temperature sensor:	YES, the connection between AIN1/DIN1 and AIN2/DIN2	
Type of ext. sensor:	TC/TZ	
Temperature measurement range:	-20 °C to +120 °C	
Temp. measurement accuracy:	0.5 °C from range	
Outputs		
Indication:	two-colored LED (red, green)	
Number of LEDs:	1	
Communication		
Installation BUS:	BUS	
Power supply		
Supply voltage/tolerance:	27 V DC, -20/+10 %	
Dissipated power:	max. 0.5 W	
Rated current:	25 mA (at 27 V DC), from BUS	
Connection		
Terminals:	0.5 - 1 mm ²	
Operating conditions		
Operating temperature:	-20 to +55 °C	
Storing temperature:	-30 to +70 °C	
Protection degree:	IP20	
Overvoltage category:	II.	
Pollution degree:	2	
Operation position:	any	
Installation:	into installation box	
Dimensions and weight		
Dimensions		
- plastic:	85.6 x 85.6 x 42 mm	
- metal, glass, wood, granite:	94 x 94 x 36 mm	
Weight:	55 g (without frame)	
Standards:	EN 63044-1	

- Wall controllers with low-upstroke control WSB3-20 and WSB3-20H are the main and most frequently used units (controller) in the iNELS system.
- Built-in micro-buttons with low upstroke offer elegant and easy controlling.
- Wall switches WSB3-20 and WSB3-20H are available in 2-channels version.
- Double color (red/green) LED diode indicates either status of controlled appliances or status of any sensor or actuator in the system.
- Wall buttons in WSB3 series are compatible with both types of frames LOGUS⁹⁰ (85.6 x 85.6 or 94 x 94 mm), therefore you can combine them with double and triple frames and classic products of the series.
- Each controller is equipped with a temperature sensor. It is also equipped with two analog/digital inputs (AIN/DIN), which can be used to connect two potentialless contacts or one external temperature sensor TC/TZ (e.g. for measuring floor temperature).
- Wall button WSB3-20H is comparable to the WSB3-20 but additionally equipped with a relative humidity meter, and for better access of air to the sensor can be used with 99621T including accessories 99622 (Vista MT) and 99,623 (Vista IRMT), instead of the housing cover 99601T.
- Compared to standard wall buttons WSB3-20 and WSB3-20H are more flexible and multifunctional. You can for example controll appliances by short and long push of the button (e.g.: dimming, shutter control, scenes).
- Each button can control any appliance in the system and can use a variety of centralized or time controlled features. Accordingly, the customer can choose the simplicity/complexity of the operation. The big advantage is the possibility to change the method of control by only making software modifications without physical interventions into the structure of the building.
- Each button (fold) can have different functional modes beside lighting control:
 - a) Classic wall-switch:
 - upper button ON, bottom button OFF
 - b) Button controller (impulse relay):
 - first press ON, second press OFF
 - c) Dimmer:
 - short press – ON/OFF
 - d) Time switch:
 - ON after press, automatically OFF after set time
 - e) Setting light scenes – for example: for watching TV:
 - shutters down
 - main light 30% intensity
 - wall-lamps 50% intensity
- WSB3 in LOGUS⁹⁰ design is designed for mounting into an installation box.

Connection

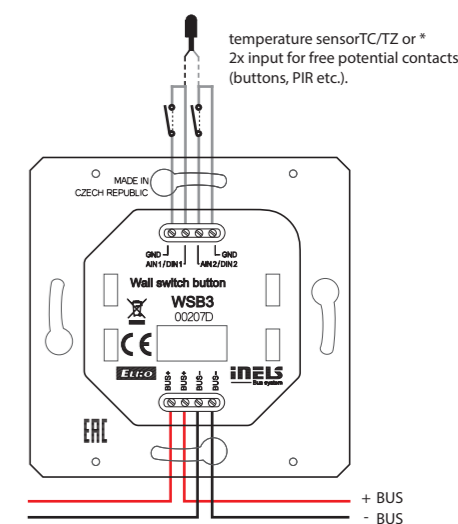

* The choice is made in iDM3 for each unit separately.

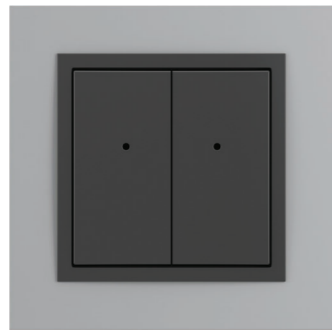

EAN code
WSB3-40: 8595188132336
WSB3-40H: 8595188133043

Order Code:
WSB3-40: 3233
WSB3-40H: 3304

Technical parameters	WSB3-40	WSB3-40H
Inputs		
Temperature measuring:	YES, built-in temperature sensor	
Scope and accuracy of temp. measuring:	0 to +55 °C ; 0.3 °C from the range	
Number of control buttons:	4	
Humidity measurement:	NO	YES
Humidity measurement range:	-	0 to 99 % Relative humidity
Humidity measurement accuracy:	-	± 3 % Relative humidity
Inputs:	2x AIN/DIN	
External temperature sensor:	YES, the connection between AIN1/DIN1 and AIN2/DIN2	
Type of external sensor:	TC/TZ	
Temp. measurement range:	-20 °C to +120 °C	
Temp. measurement accuracy:	0.5 °C from range	
Outputs		
Indication:	two-colored LED (red, green)	
Number of LEDs:	2	
Communication		
Installation BUS:	BUS	
Power supply		
Supply voltage/tolerance:	27 V DC, -20/+10 %	
Dissipated power:	max. 0.5 W	
Rated current:	25 mA (at 27 V DC), from BUS	
Connection		
Terminals:	0.5 - 1 mm ²	
Operating conditions		
Operating temperature:	-20 to +55 °C	
Storing temperature:	-30 to +70 °C	
Protection degree:	IP20	
Oversvoltage category:	II.	
Pollution degree:	2	
Operation position:	any	
Installation:	into installation box	
Dimensions and weight		
Dimensions		
- plastic:	85.6 x 85.6 x 42 mm	
- metal, glass, wood, granite:	94 x 94 x 36 mm	
Weight:	55 g (without frame)	
Standards:	EN 63044-1	

* The choice is made in iDM3 for each unit separately.

- Wall mounted controllers with upstroke control WSB3-40 and WSB3-40H are the basic and most popular feature (control) of the INELS system.
- Built-in micro-switch with low upstroke offers elegant and pleasant control.
- Controllers WSB3-40 and WSB3-40H are supplied with 4-channels.
- Two-coloured indication LEDs located in each controller, can signal the status of controlled appliances or the status of any sensor or actuator in the system.
- Wall buttons in WSB3 series are compatible with both types of frames LOGUS⁹⁰ (85.6x85.6 or 94x94 mm), therefore you can combine them with double and triple frames and classic products of the series.
- Each controller is equipped with a temperature sensor. It is also equipped with two analog/digital inputs (AIN/DIN), which can be used to connect two potentialless contacts or one external temperature sensor TC/TZ (e.g. for measuring floor temperature).
- Compared to standard wall buttons WSB3-20 and WSB3-20H are more flexible and multifunctional. You can for example controll appliances by short and long push of the button (e.g.: dimming, shutter control, scenes).
- Each button can control any appliance in the system and can use a variety of centralized or time controlled features. Accordingly, the customer can choose the simplicity/complexity of the operation. The big advantage is the possibility to change the method of control by only making software modifications without physical interventions into the structure of the building.
- Each button (fold) can have different functional modes beside lighting control:
 - a) Classic wall-switch:
 - upper button ON, bottom button OFF
 - b) Button controller (impulse relay):
 - first press ON, second press OFF
 - c) Dimmer:
 - short press – ON/OFF
 - d) Time switch:
 - ON after press, automatically OFF after set time
 - e) Setting light scenes – for example: for watching TV:
 - shutters down
 - main light 30% intensity
 - wall-lamps 50% intensity
- WSB3 in LOGUS⁹⁰ design is designed for mounting into an installation box.

Connection

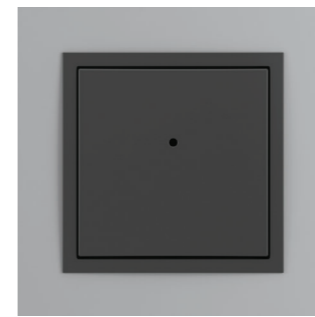
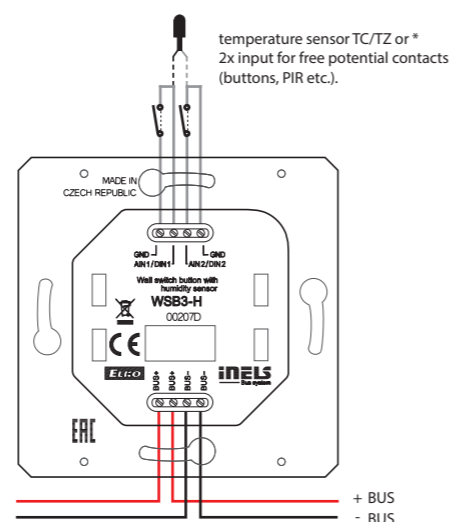

EAN code
WMR3-21: 8595188132756
Order Code: 3275

Technical parameters	WMR3-21
Inputs	
Number of control buttons:	2
RFID readers	
Supported frequencies:	13.56 MHz
Card Type:	MIFARE Ultralight, DESFire 2K (EV1), DESFire 4K (EV1)
Outputs	
Output:	1x changeover 8 A/AgSnO ₂
Indication:	two-color LED (red, green)
Acoustic output:	piezo-changer
Switching voltage:	230 V A/30 V DC
Switching output:	2000 VA/AC1; 240 W/DC
Peak current:	20 A/<3s
Insulation voltage between relay outputs and internal circuits:	3.75 kV, SELV according to EN 60950
Minimal switched current:	10 mA/10 V
Switching frequency without load:	300 min ⁻¹
Switching frequency with rated load:	15 min ⁻¹
Mechanical life:	1x 10 ⁷
Electrical life AC1:	1x 10 ⁵
Communication	
Installation BUS:	BUS
Power supply	
Supply voltage/tolerance:	27 V DC, -20/+10 %
Dissipated power:	max. 0.5 W
Rated current:	50 mA (at 27 V DC), from BUS
Connection	
Data:	terminals, 0.5 - 1 mm ²
Network:	max. 2.5 mm ² /1.5 mm ² with sleeve
Operating conditions	
Operating temperature:	-20 to +55 °C
Storing temperature:	-30 to +70 °C
Protection degree:	IP20
Oversvoltage category:	II.
Pollution degree:	2
Operation position:	any
Installation:	into installation box
Dimensions and weight	
Dimensions	
- plastic:	85.6 x 85.6 x 42 mm
- metal, glass, wood, granite:	94 x 94 x 36 mm
Weight:	68 g (without frame)
Standards:	EN 63044-1

- WMR3-21 is a wall-mounted card reader that is designed for read contactless media (smart cards, key chains, etc.), which are used for controlling access to buildings or their parts.
- With the glass controller WMR3-21 users will appreciate the easy of control using two push buttons, which can be assigned different control functions lighting, shading, scenes, heating, etc.
- WMR3-21 reader can be used to control the security system (locking/unlocking) access system (opening doors, gates, etc.) or appliances (based on assigned rights).
- WMR3-21 supports RFID media with the carrier frequency of 13.56 MHz. Supported card types MIFARE Ultralight, DESFire 2K (EV1), DESFire 4K (EV1).
- WMR3-21 is also equipped with 8 A relay output with changeover contact AgSnO₂, by which controlled devices can be switched directly (or any actuator in the system can be set in software iDM3).
- Indication two-color LED in the controller cover can indicate not only the status of controlled appliance, but also the status of any sensor or actuator in the system.
- Wall card reader WMR3-21 is compatible with both types of frames LOGUS⁹⁰ (85.6 x 85.6 or 94 x 94 mm), therefore you can combine them with double and triple frames and classic products of the series.

Connection

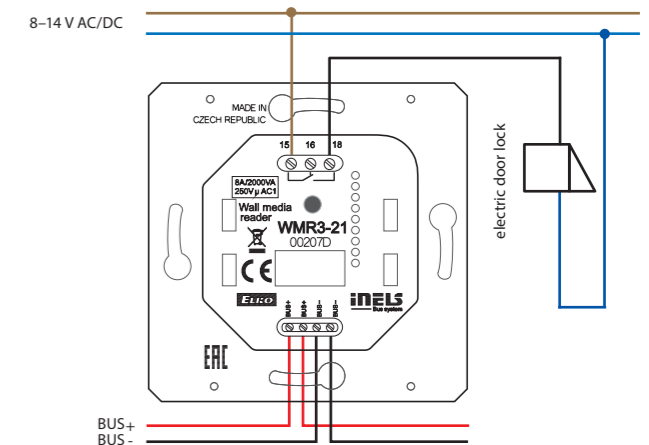



EAN code: GCR3-30/B: 8595188191692
 GCR3-30/W: 8595188191708
 GCR3-230/B: 8595188191715
 GCR3-230/W: 8595188191722

Order Code: GCR3-30/B: 9169
 GCR3-30/W: 9170
 GCR3-230/B: 9171
 GCR3-230/W: 9172

Technical parameters	GCR3-30	GCR3-230
Inputs		
Illuminance sensor:	1 to 100 000 Lx	
Proximity Sensor:	(SWP/SBP models) motion detection at a distance of 0.25 m	
RFID readers		
Supported frequencies:	13.56 MHz	
Card Type:	Mifare 1k, 4k, Ultralight, DesFire, ISO/IEC 14443-4 (CD97BX, CD light, P5CN072 (SMX) Innovision jewel (IRT5001), FeliCa (RCS_860, RCS_854)	
Buttons		
Number of control buttons:	3	
Type:	capacitive	
Indication:	coloured illuminated symbol	
Outputs		
Acoustic output:	piezo-changer	
Communication		
Installation BUS:	BUS	
Power supply		
Supply voltage/tolerance:	27 V DC, -20/+10 %	
Dissipated power:	max. 0.5 W	
Rated current:	25-50 mA (at 27 V DC), from BUS	
Connection		
Terminals:	EIB ø 0.6 - 0.8 mm ²	
Operating conditions		
Relative humidity:	max. 80 %	
Operating temperature:	-20 to +55 °C	
Storing temperature:	-30 to +70 °C	
Protection degree:	IP20	
Overvoltage category:	II.	
Pollution degree:	2	
Operation position:	any	
Installation:	on the wall, observing the conditions for correct installation of the sensor	
Dimensions and weight		
Dimensions:	94 x 94 x 41 mm 100 x 100 x 8 mm	
Weight:	154 g	
Standards:	EN 63044-1	



- Glass card reader GCR3-30 is part of a comprehensive range of glass iNELS control units and can be advantageously used in all projects, e.g. guest room management system (GRMS).
- GCR3-30 card reader is designed for reading smart cards, which are intended to enter the hotel room or any other part of the building.
- GCR3-30 supports RFID media with a carrier frequency of 13.56 MHz. Supported card types Mifare 1k, 4k, Ultralight, DesFire, ISO/IEC 14443-4 (CD97BX, CD light, P5CN072 (SMX) Innovision jewel (IRT5001), FeliCa (RCS_860, RCS_854)
- The GCR3 is a design component of the iNELS system and is available in elegant black (GCR3-30/B, GCR3-230/B) and white (GCR3-30/W, GCR3-230/W) variants. The GCR3-30 models feature a square design, while the GCR3-230 models come in a round design.
- Engraving of symbols is possible upon a request. The room number as well as the logo of the hotel can be also engraved on each component.
- The controller is also equipped with 3x capacitive touch button with different function or macro (set of functions). It is therefore possible to use one button to control several application. For eg. Function of bell and with two icons to indicate the status of guest requests, e.g. "Do Not Disturb" and "Make Up Room", whose state guest can set from other glass switch panel.
- Individual symbols can be illuminated in one of seven colours - red, green, blue, yellow, pink, turquoise and white.
- Reader GCR3-30 is equipped with a sensor for ambient light intensity and proximity sensor. Based on information from the sensor it can e.g. switch the lighting circuits in the corridor.
- All versions are in the size of the standard module (94x94 mm) and are designed for mounting into an installation.
- GCR3-30 are designed for mounting into an installation box.

Instrument description

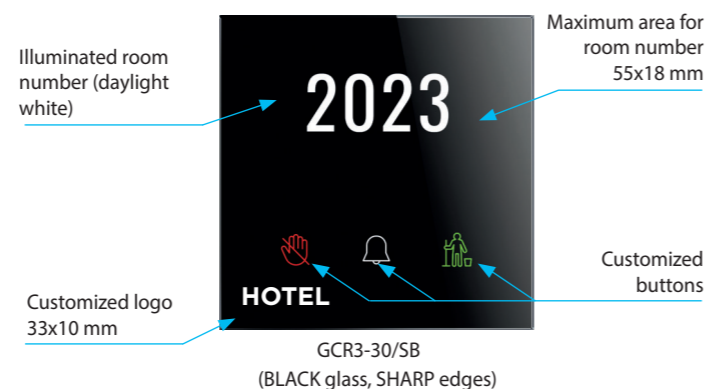

Button legend

Create your glass design here:
icons.inels.com



Connection

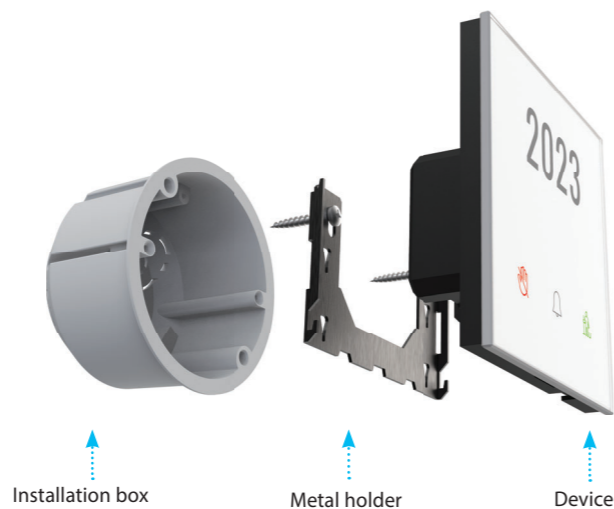

N

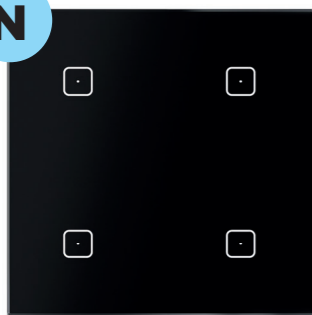

EAN code
GSB3-40/B: 8595188132909
Order Code: 8879

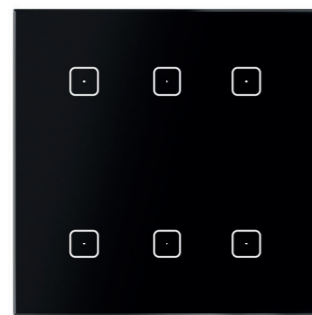

EAN code
GSB3-60/B: 8595188132916
Order Code: 8877

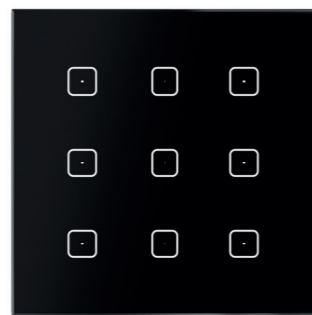

EAN code
GSB3-90/B: 8595188188272
Order Code: 8827

Technical parameters GSB3-XX, GSB3-2XX

Inputs

Temperature measuring:	YES, built-in temperature sensor
Scope and accuracy of temp. measurement:	0 to +55 °C; 0.3 °C from the range
Humidity measurement:	YES
Humidity measurement range:	0 to 99 % RH
Inputs:	AIN/DIN
Resolution:	by setting 10-bit
External temperature sensor:	YES, the connection between AIN1/DIN1 and AIN2/DIN2
Type of external sensor:	TC/TZ
Temperature measurement range:	-20 °C to +120 °C
Temperature measurement accuracy:	0.5 °C from the range

Buttons

Number of control buttons:	4	6	9
Type:	capacitive		
Indication:	blue highlighted point		
Outputs			
Acoustic output:	piezo-changer		
Communication			
Installation BUS:	BUS		
Power supply			
Supply voltage/tolerance:	27 V DC, -20/+10 %		
Dissipated power:	max. 0.5 W		
Rated current:	20-38 mA	20-45 mA	20-50 mA
	(at 27 V DC), from BUS		

Connection

Terminals:	EIB \varnothing 0.6 - 0.8 mm ²
------------	---

Operating conditions

Relative humidity:	max. 80 %
Operating temperature:	-20 to +55 °C
Storing temperature:	-30 to +70 °C
Protection degree:	IP20
Overvoltage category:	II.
Pollution degree:	2
Operation position:	any
Installation:	on the wall, observing the conditions for correct installation of the sensor

Dimensions and weight

Dimensions:	94 x 94 x 41 mm 100 x 100 x 8 mm
Weight:	154 g
Standards:	EN 63044-1

- Glass touch controllers GSB3-XXX are part of a comprehensive range of glass iNELS control units and can be advantageously used in all projects for example as a part of guest room management system (GRMS).
- The GSB3-40, GSB3-60, and GSB3-90 models feature a square design, while the GSB3-240, GSB3-260, and GSB3-290 models come in a round design.
- GSB3-40, GSB3-240 is equipped with four, GSB3-60, GSB3-260 six and GSB3-90, GSB3-290 nine touch buttons whose functions can easily modify by the software.
- The glass touch controllers is equipped with an integrated temperature sensor. It is also equipped with analog-to-digital input (AIN/DIN), which can be used to connect potential-free contact or external temperature sensor TC/TZ (for example temperature measurement of the floor).
- Advantages over conventional switches/buttons are saving space, signalling the state of any system output, the ability to measure temperature as well as the ability to connect external buttons or detectors.
- Each button can control any actuator (appliance) in the system. Also, you can assign each button a different function or macro (set of functions). It is therefore possible to use one button to control several appliances at once.
- Glass touch panel is a design component of the iNELS system and is available in elegant black (GSB3-XXX/B) and white (GSB3-XXX/W) versions.
- The individual capacitive buttons are point-illuminated by a blue LED indicating the status of the controlled output.
- All versions are in the size of the standard module (94x94 mm) and designed for mounting into an installation box.

Another view



GSB3-60B

N

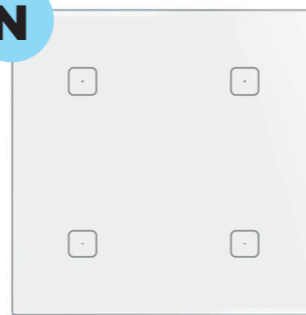

EAN code
GSB3-40/W: 8595188132954
Order Code: 8880

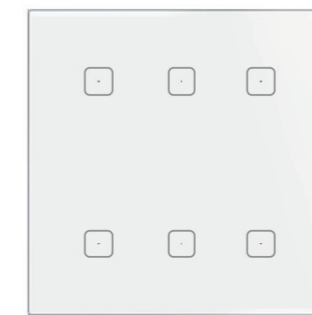

EAN code
GSB3-60/W: 8595188132985
Order Code: 8878

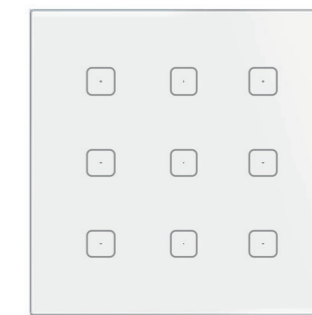

EAN code
GSB3-90/W: 8595188188289
Order Code: 8828

N

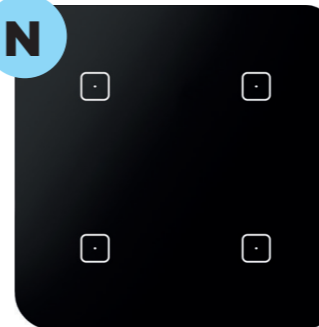

EAN code
GSB3-240/B: 8595188189569
Order Code: 8956



EAN code
GSB3-260/B: 8595188189583
Order Code: 8958

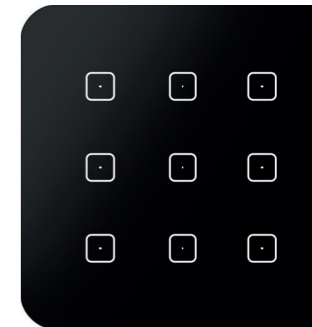

EAN code
GSB3-290/B: 8595188189606
Order Code: 8960

N

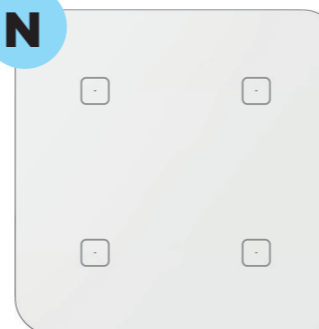

EAN code
GSB3-240/W: 8595188189576
Order Code: 8957

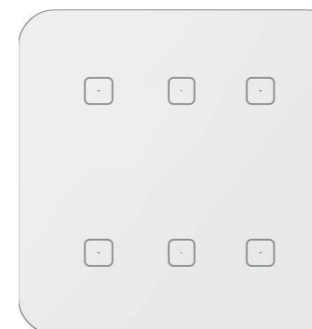

EAN code
GSB3-260/W: 8595188189590
Order Code: 8959

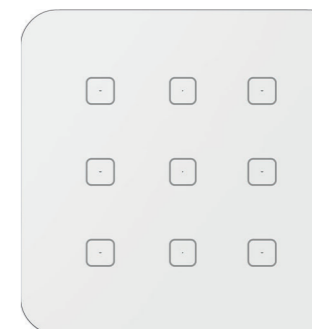

EAN code
GSB3-290/W: 8595188189613
Order Code: 8961

Connection

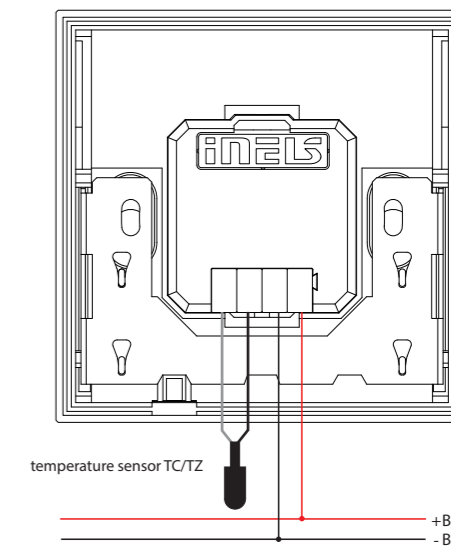
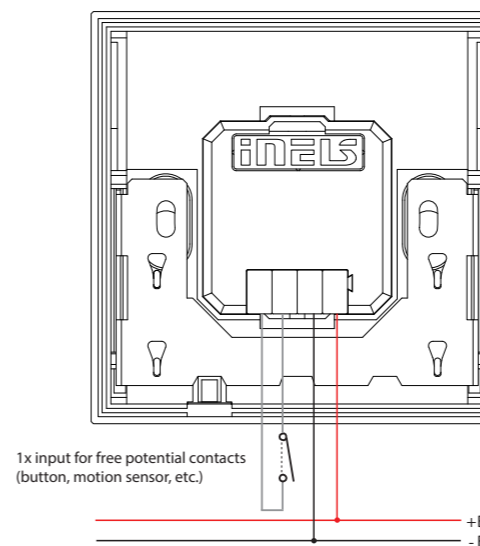



EAN code
GSB3-40/SB: 8595188156233
GSB3-40/SBP: 8595188188883 (proximity)
Order code
GSB3-40/SB: 8875
GSB3-40/SBP: 8888 (proximity)

EAN code
GSB3-60/SB: 8595188156257
GSB3-60/SBP: 8595188188869 (proximity)
Order code
GSB3-60/SB: 8873
GSB3-60/SBP: 8886 (proximity)

EAN code
GSB3-90/SB: 8595188188258
GSB3-90/SBP: 8595188188845 (proximity)
Order code
GSB3-90/SB: 8825
GSB3-90/SBP: 8884 (proximity)

Technical parameters GSB3-XX/S, GSB3-2XX/S

Inputs

Temperature measuring:	YES, built-in temperature sensor
Scope and accuracy of temp. measurement:	0 to +55 °C; 0.3 °C from the range
Humidity measurement:	YES
Humidity measurement range:	0 to 99 % RH
Inputs:	AIN/DIN
Resolution:	by setting 10-bit
External temperature sensor:	YES, the connection between AIN1/DIN1 and AIN2/DIN2
Type of external sensor:	TC/TZ
Temperature measurement range:	-20 °C to +120 °C
Temperature measurement accuracy:	0.5 °C from the range
Illuminance sensor:	1 to 100 000 Lx
Proximity Sensor:	(SWP/SBP models) motion detection at a distance of 0.25 m

Buttons

Number of control buttons:	4	6	9
Type:	capacitive		
Indication:	coloured illuminated symbol		

Outputs

Acoustic output:	piezo-changer
------------------	---------------

Communication

Installation BUS:	BUS
-------------------	-----

Power supply

Supply voltage/tolerance:	27 V DC, -20/+10 %		
Dissipated power:	max. 0.5 W		
Rated current:	25-43 mA	25-50 mA	25-50 mA
	(at 27 V DC), from BUS		

Connection

Terminals:	EIB \varnothing 0.6 - 0.8 mm ²
------------	---

Operating conditions

Relative humidity:	max. 80 %
Operating temperature:	-20 to +55 °C
Storing temperature:	-30 to +70 °C
Protection degree:	IP20
Overvoltage category:	II.
Pollution degree:	2
Operation position:	any
Installation:	on the wall, observing the conditions for correct installation of the sensor

Dimensions and weight

Dimensions:	94 x 94 x 41 mm 100 x 100 x 8 mm
Weight:	154 g
Standards:	EN 63044-1

- Glass touch controllers with symbols GSB3-XX/S are part of a comprehensive range of glass iNELS control units and can be advantageously used in all projects for example as a part of guest room management system (GRMS).
- The GSB3-40/S, GSB3-60/S, and GSB3-90/S models feature a square design, while the GSB3-240/S, GSB3-260/S, and GSB3-290/S models come in a round design.
- GSB3-40/S, GSB3-240/S is equipped with four, GSB3-60/S, GSB3-260/S six and GSB3-90/S, GSB3-290/S nine touch buttons whose functions can easily modify by the software.
- Symbols on the glass touch controllers can be engraved upon request, allowing for personalized and tailored solutions to meet specific project needs. Additionally, there is an option to engrave text for each button, further enhancing customization possibilities.
- The glass touch controllers is equipped with an integrated temperature sensor. It is also equipped with analog-to-digital input (AIN/DIN), which can be used to connect potential-free contact or external temperature sensor TC/TZ (for example temperature measurement of the floor).
- Advantages over conventional switches/buttons are saving space, signalling the state of any system output, the ability to measure temperature as well as the ability to connect external buttons or detectors.
- Each button can control any actuator (appliance) in the system. Also, you can assign each button a different function or macro (set of functions). It is therefore possible to use one button to control several appliances at once.
- Glass touch panel is a design component of the iNELS system and is available in elegant black (GSB3-XXX/SB) and white (GSB3-XXX/SW) versions.
- Individual symbols can be illuminated in one of seven colours - red, green, blue, yellow, pink, turquoise and white.
- All versions are in the size of the standard module (94x94 mm) and are designed for mounting into an installation box.
- In addition to all the features in symbol models. The glass touch controllers in the SBP/SWP version are equipped with a proximity sensor, which can light up the symbols by approaching the unit to approx. 0.25 m.
- SWP/SBP models are also equipped with a sensor of ambient light intensity. Based on information from the sensor it can switch backlight of symbols or perform various actions in the iDM3 software, for example also switch the lighting circuits in the room.

Another view



GSB3-260SW

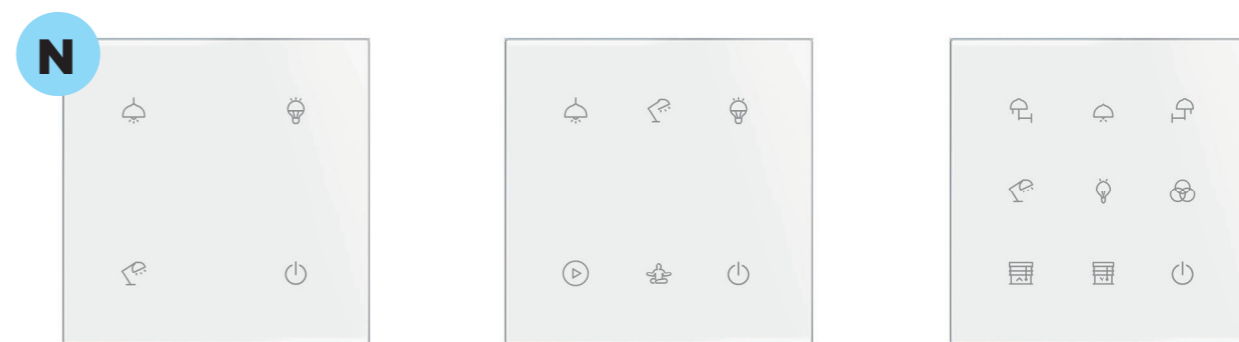

EAN code
GSB3-40/SW: 8595188156240
GSB3-40/SWP: 8595188188890 (proximity)
Order code
GSB3-40/SW: 8876
GSB3-40/SWP: 8889 (proximity)

EAN code
GSB3-60/SW: 8595188156264
GSB3-60/SWP: 8595188188876 (proximity)
Order code
GSB3-60/SW: 8874
GSB3-60/SWP: 8887 (proximity)

EAN code
GSB3-90/SW: 8595188188265
GSB3-90/SWP: 8595188188852 (proximity)
Order Code:
GSB3-90/SW: 8826
GSB3-90/SWP: 8885



EAN code
GSB3-240/SB: 8595188189620
GSB3-240/SBP: 8595188189682 (proximity)
Order code
GSB3-240/SB: 8962
GSB3-240/SBP: 8968 (proximity)

EAN code
GSB3-260/SB: 8595188189644
GSB3-260/SBP: 8595188189705 (proximity)
Order code
GSB3-260/SB: 8964
GSB3-260/SBP: 8970 (proximity)

EAN code
GSB3-290/SB: 8595188189668
GSB3-290/SBP: 8595188189729 (proximity)
Order Code:
GSB3-290/SB: 8966
GSB3-290/SBP: 8972 (proximity)



EAN code
GSB3-240/SW: 8595188189637
GSB3-240/SWP: 8595188189699 (proximity)
Order code
GSB3-240/SW: 8963
GSB3-240/SWP: 8969 (proximity)

EAN code
GSB3-260/SW: 8595188189651
GSB3-260/SWP: 8595188189712 (proximity)
Order code
GSB3-260/SW: 8965
GSB3-260/SWP: 8971 (proximity)

EAN code
GSB3-290/SW: 8595188189675
GSB3-290/SWP: 8595188189736 (proximity)
Order Code:
GSB3-290/SW: 8967
GSB3-290/SWP: 8973 (proximity)

The picture of device is illustrative, the icons (symbols) are configurable by the customer.

Connection

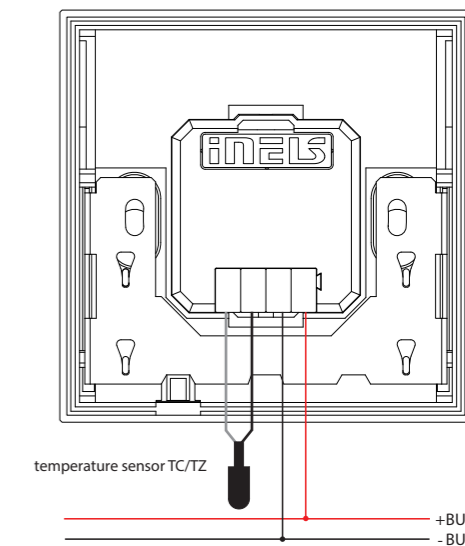
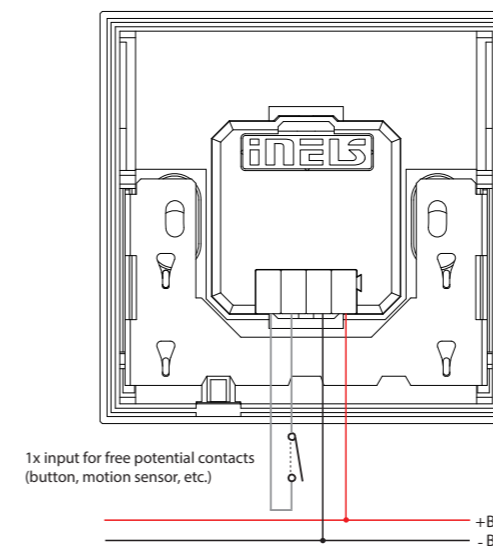

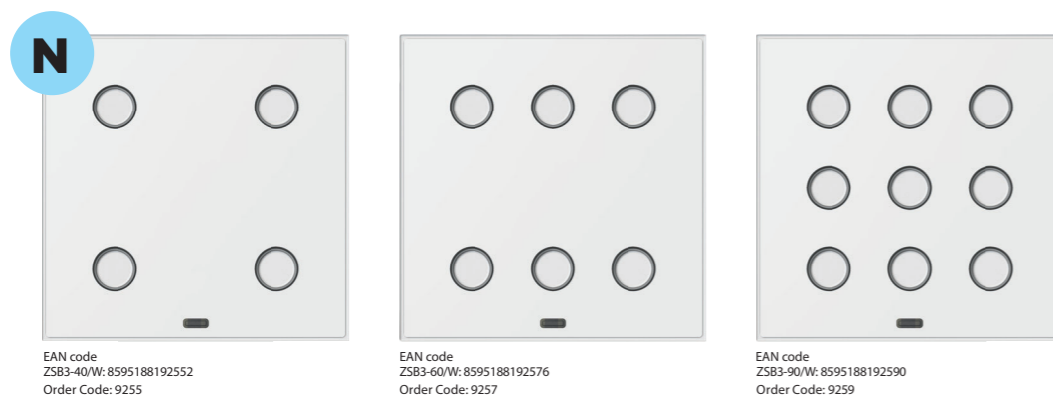

Technical parameters	ZSB3-40	ZSB3-60	ZSB3-90
Inputs			
Temperature measuring:	YES, built-in temperature sensor		
Scope and accuracy of temp. measurement:	0 to +55 °C; 0.3 °C from the range		
Humidity measurement:	YES		
Humidity measurement range:	0 to 99 % RH		
Inputs:	AIN/DIN		
External temperature sensor:	YES, the connection between AIN1/DIN1 and AIN2/DIN2		
Type of external sensor:	TC/TZ		
Temperature measurement range:	-20 °C to +120 °C		
Temperature measurement accuracy:	0.5 °C from the range		
Illuminance sensor:	1 to 12 000 Lx		
Buttons			
Number of control buttons:	4	6	9
Type:	button		
Indication:	white illuminated button		
Outputs			
Acoustic output:	piezo-changer		
Communication			
Installation BUS:	BUS		
Power supply			
Supply voltage/tolerance:	27 V DC, -20/+10 %		
Dissipated power:	max. 0.5 W		
Rated current:	25-43 mA	25-50 mA	25-50 mA
	(at 27 V DC), from BUS		
Connection			
Terminals:	EIB \varnothing 0.6 - 0.8 mm ²		
Operating conditions			
Relative humidity:	max. 80 %		
Operating temperature:	-20 to +55 °C		
Storing temperature:	-30 to +70 °C		
Protection degree:	IP40		
Overvoltage category:	II.		
Pollution degree:	2		
Operation position:	any		
Installation:	on the wall, observing the conditions for correct installation of the sensor		
Dimensions and weight			
Dimensions:	94 x 94 x 40 mm		
Weight:	154 g		
Standards:	EN 63044-1		

- Glass switch buttons ZSB3-40/XX, ZSB3-60/XX and ZSB3-90/XX are part of a comprehensive range of iNELS control units and can be advantageously used in all projects.
- ZSB3 comes with premium glass plates in the white and black.
- ZSB3-40/XX is equipped with four, ZSB3-60/XX six and ZSB3-90/XX nine touch buttons whose functions can easily modify by the software.
- The glass switch button are equipped with an integrated temperature sensor. It is also equipped with analog-to-digital input (AIN/DIN), which can be used to connect potential-free contact or external temperature sensor TC/TZ (for example temperature measurement of the floor).
- Advantages over conventional switches/buttons are saving space, signalling the state of any system output, the ability to measure temperature as well as the ability to connect external buttons or detectors.
- Each button can control any actuator (appliance) in the system. Also, you can assign each button a different function or macro (set of functions). It is therefore possible to use one button to control several appliances at once.
- Glass switch button is a design component of the iNELS system and is available in white and black.
- There is an option upon request to engrave text for each button, further enhancing customization possibilities.
- Individual buttons can be illuminated in white.
- ZSB3-40/XX, ZSB3-60/XX and ZSB3-90/XX are designed for mounting into an installation box.
- All versions are in the size of the standard module (94x94 mm).

Another view



ZSB3-90/B



Connection

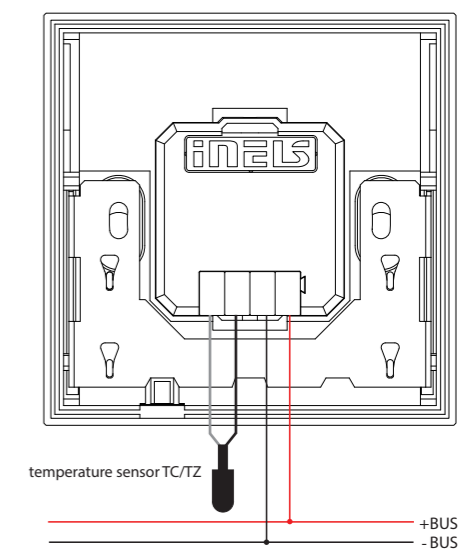
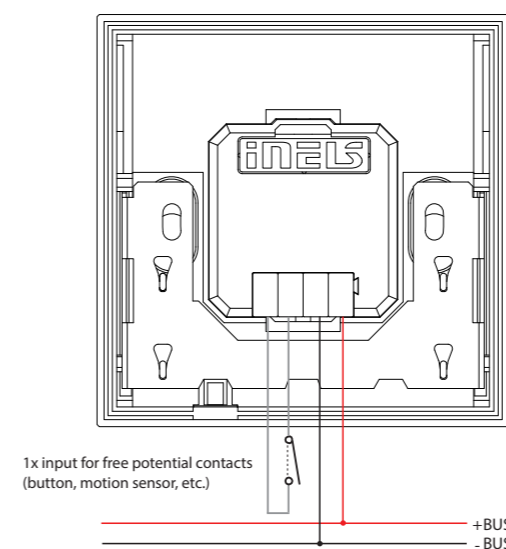

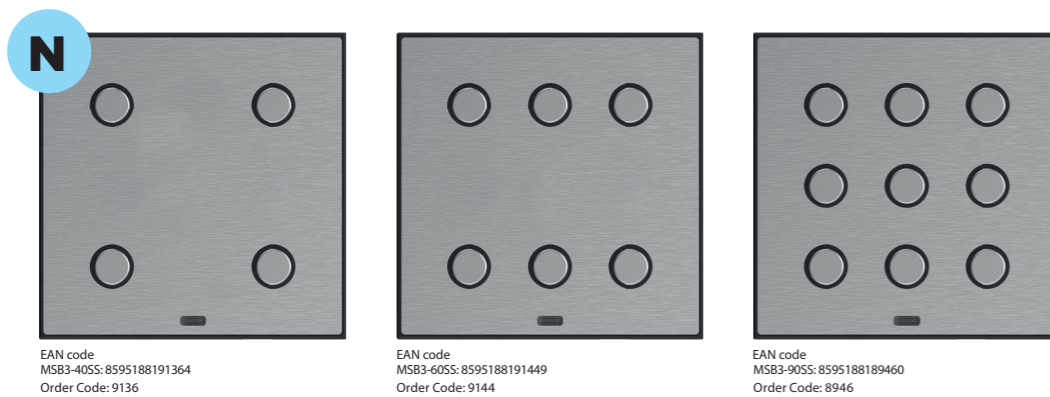

Technical parameters	MSB3-40	MSB3-60	MSB3-90
Inputs			
Temperature measuring:	YES, built-in temperature sensor		
Scope and accuracy of temp. measurement:	0 to +55 °C; 0.3 °C from the range		
Humidity measurement:	YES		
Humidity measurement range:	0 to 99 % RH		
Inputs:	AIN/DIN		
External temperature sensor:	YES, the connection between AIN1/DIN1 and AIN2/DIN2		
Type of external sensor:	TC/TZ		
Temperature measurement range:	-20 °C to +120 °C		
Temperature measurement accuracy:	0.5 °C from the range		
Illuminance sensor:	1 to 12 000 Lx		
Buttons			
Number of control buttons:	4	6	9
Type:	button		
Indication:	white illuminated button		
Outputs			
Acoustic output:	piezo-changer		
Communication			
Installation BUS:	BUS		
Power supply			
Supply voltage/tolerance:	27 V DC, -20/+10 %		
Dissipated power:	max. 0.5 W		
Rated current:	25-43 mA	25-50 mA	25-50 mA
	(at 27 V DC), from BUS		
Connection			
Terminals:	EIB ø 0.6 - 0.8 mm ²		
Operating conditions			
Relative humidity:	max. 80 %		
Operating temperature:	-20 to +55 °C		
Storing temperature:	-30 to +70 °C		
Protection degree:	IP40		
Overvoltage category:	II.		
Pollution degree:	2		
Operation position:	any		
Installation:	on the wall, observing the conditions for correct installation of the sensor		
Dimensions and weight			
Dimensions:	94 x 94 x 40 mm		
Weight:	154 g		
Standards:	EN 63044-1		

Example

MSB3- XX/BB = Graphite black plate + Graphite black button
 MSB3- XX/GG = Satin brass plate + Satin Brass button
 MSB3- XX/SS = Brushed silver plate + Brushed silver button
 MSB3- XX/CC = Antique copper plate + Antique copper button

- Metal switch buttons MSB3-40/XX, MSB3-60/XX and MSB3-90/XX are part of a comprehensive range of iNELS control units and can be advantageously used in all projects.
- MSB3 comes with premium metal plates in the antique copper, satin brass, brushed silver, and graphite black finish.
- MSB3-40/XX is equipped with four, MSB3-60/XX six and MSB3-90/XX nine touch buttons whose functions can easily modify by the software.
- The metal switch button are equipped with an integrated temperature sensor. It is also equipped with analog-to-digital input (AIN/DIN), which can be used to connect potential-free contact or external temperature sensor TC/TZ (for example temperature measurement of the floor).
- Advantages over conventional switches/buttons are saving space, signalling the state of any system output, the ability to measure temperature as well as the ability to connect external buttons or detectors.
- Each button can control any actuator (appliance) in the system. Also, you can assign each button a different function or macro (set of functions). It is therefore possible to use one button to control several appliances at once.
- Metal switch button is a design component of the iNELS system and is available in antique copper, satin brass, brushed silver, and graphite black versions.
- There is an option upon request to engrave text for each button, further enhancing customization possibilities.
- Individual buttons can be illuminated in white.
- MSB3-40/XX, MSB3-60/XX and MSB3-90/XX are designed for mounting into an installation box.
- All versions are in the size of the standard module (94x94 mm).

Another view

MSB3-90/CC

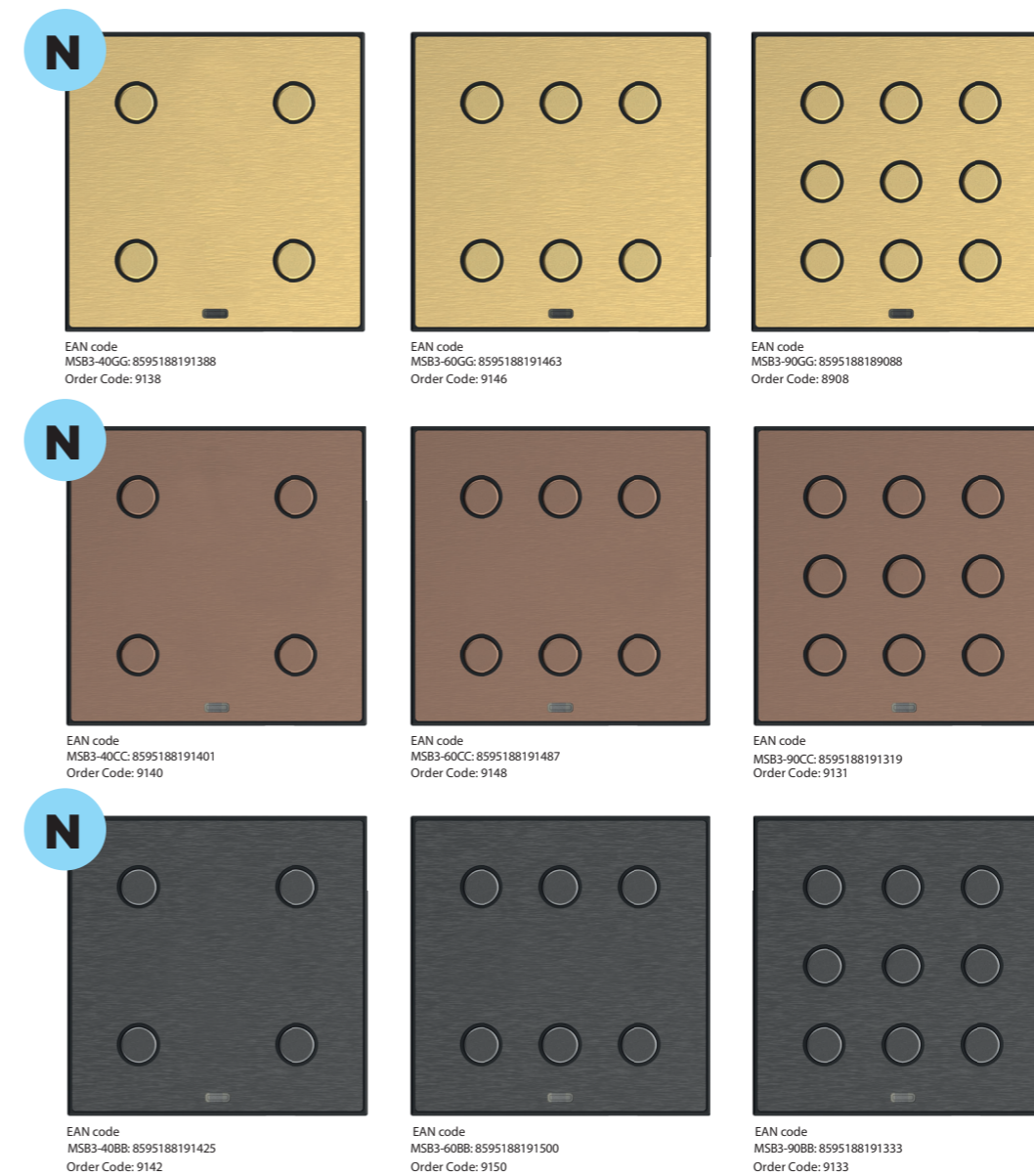
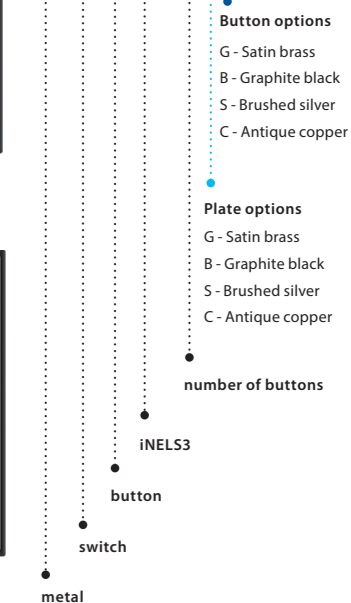
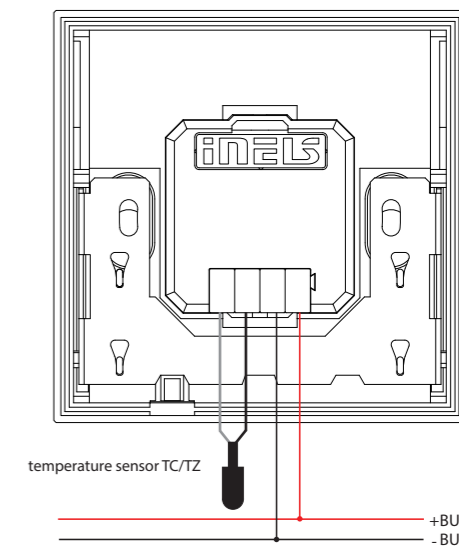
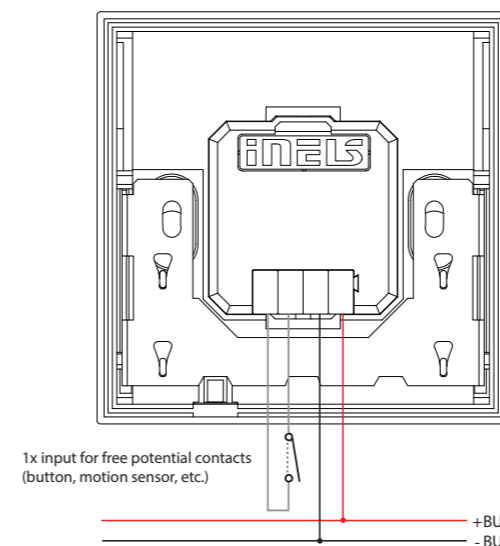
**MSB3-90/xx****Connection**

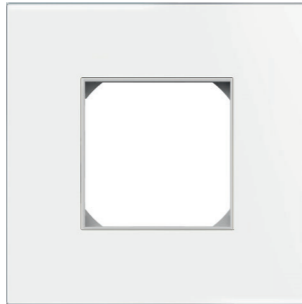

GSF3/B
B - Black glass
EAN 8595188192453
Order code 9245

GSF3/W
W - White glass
EAN 8595188192460
Order code 9246

Example

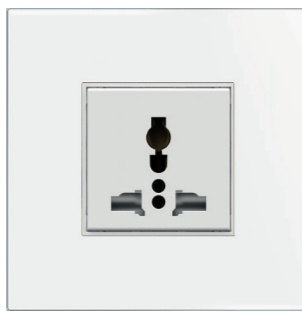

B - Black glass

W - White glass

B - Black glass

W - White glass

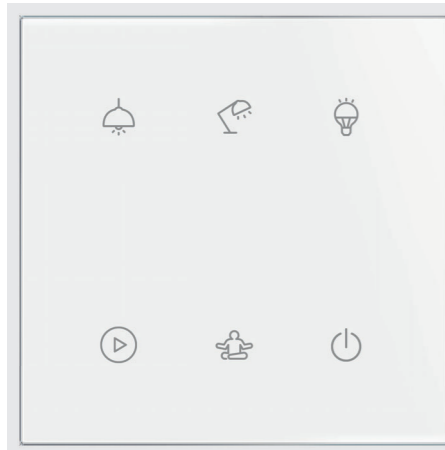

Glass switch buttons with symbols

AC power multistandard socket PMS

USB-A+C sockets & LAN RJ45

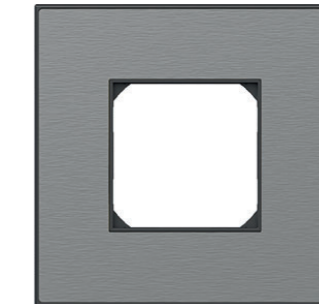
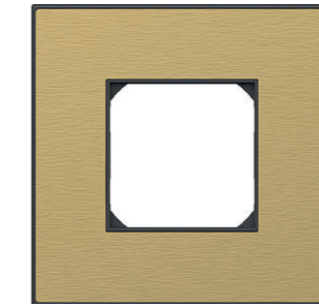
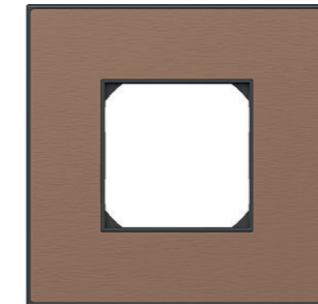
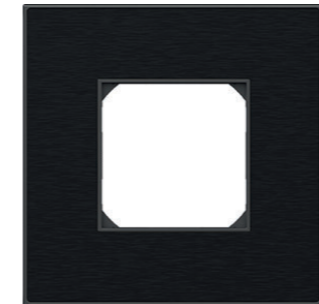

MSF3/B
B - Graphite black
EAN 8595188192446
Order code 9244

MSF3/C
C - Antique copper
EAN 8595188192439
Order code 9243

MSF3/G
G - Satin brass
EAN 8595188192422
Order code 9242

MSF3/S
S - Brushed silver
EAN 8595188192415
Order code 9241

Example



B - Graphite black

C - Antique copper

G - Satin brass

S - Brushed silver



B - Graphite black

C - Antique copper

G - Satin brass

S - Brushed silver

TEM socket



SOCKET MULTI-STANDARD+ KS 2P+E 13A 250V~ 2M
 - plug-in contacts 1.5–2.5 mm²
 - shuttered live contacts



USB POWER SUPPLY UNIT 5V 3,0A
 - power supply: 100-230V ~ 50/60Hz
 - power consumption: 300mA at 100V~/150mA at 230V ~
 - standby power consumption: 30mW at 230V~
 - nominal output voltage: 5 — (±5%) SELV
 - output ripple voltage: 150mV
 - nominal output current:
 - EM68, EQ68, EE68: 3,0 A (±10 %) ; (Type USB A / USB C)
 - efficiency: maximum of 77%
 - operating temperature: 0°C/+45°C (indoor use)
 - IP protection class: IP20, indoor use only
 - class device II
 - overvoltage category (IEC 60364-4-44) CAT II
 - a low-voltage SPD (surge protective devices) in accordance with the EN 61643-11 intended to reduce the overvoltage category III to II must be installed upstream of the USB device
 - screw contacts: max. 2.5 mm²
 - device with a contact gap of at least 3mm

Order code	EAN
<input type="checkbox"/> VM55MW-U	3831006999763
<input type="checkbox"/> VM55PW-U	3831006992016
<input checked="" type="checkbox"/> VM55SB-U	3831006992030

<input type="checkbox"/> EM68MW-U	3831006993549
<input type="checkbox"/> EM68PW-U	3831006991248
<input checked="" type="checkbox"/> EM68SB-U	3831006991262

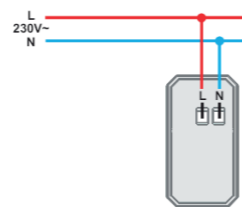
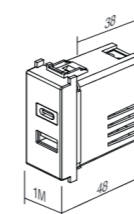

<input type="checkbox"/> TM21MW-U	3831006995321
<input type="checkbox"/> TM21PW-U	3831006933170
<input checked="" type="checkbox"/> TM21SB-U	3831006933200

<input type="checkbox"/> KM50MW-U	3831006993754
<input type="checkbox"/> KM50PW-U	3831006949454
<input checked="" type="checkbox"/> KM50SB-U	3831006949546

<input type="checkbox"/> KM39MW-U	3831006993754
<input type="checkbox"/> KM39PW-U	3831006949454
<input checked="" type="checkbox"/> KM39SB-U	3831006949546

KA27-U	3831006949430
--------	---------------

NM21-U	3831006909939
--------	---------------

BLANK 1M
 - blank modul to fill up empty spaces
 - in accordance with EN 60669-1
 - 2 pcs in a pack

ADAPTER KS UNIVERSAL 1M
 - KS keystone fixing standard
 - suitable for HDMI, USB
 - communication module not included

SOCKET CAT6 SCH KS RJ45 8/8 1M
 - KS keystone fixing standard
 - CAT6 UTP toolless, RJ45 8/8
 - in accordance with ISO/IEC 11801

CONNECTOR KS HDMI
 - KS keystone fixing standard
 - only in combination with adapter KM50
 - HDMI/HDMI

MOUNTING FRAME WITHOUT SCREWS 2M
 - mounting frame 2M without screws and without claws
 - for mounting on boxes Ø60 (HE., BE..) with screws
 - possible horizontal or vertical combinations 2x2M, 3x2M and 4x2M
 - suitable for assembling with cover plates LINE, SOFT, PURE and EDGE
 - in accordance with EN 60669-1

- MW **matte white**
- PW **polar white**
- SB **soft touch black**

Mounting frame

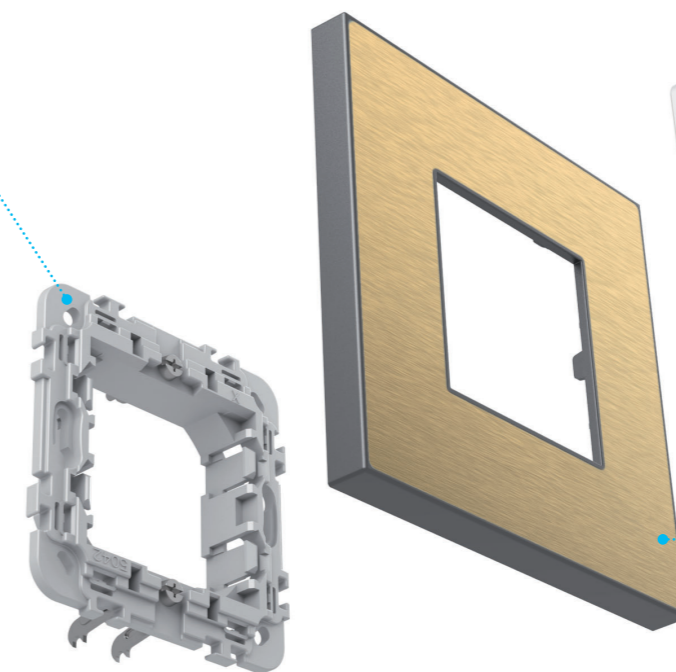

Socket from options below

Socket frames with metal or glass finishes



Blind cover 1-module PIR 1-module USB A+C 1-module HDMI 1-module LAN 1-module Multistandard socket 2-modules

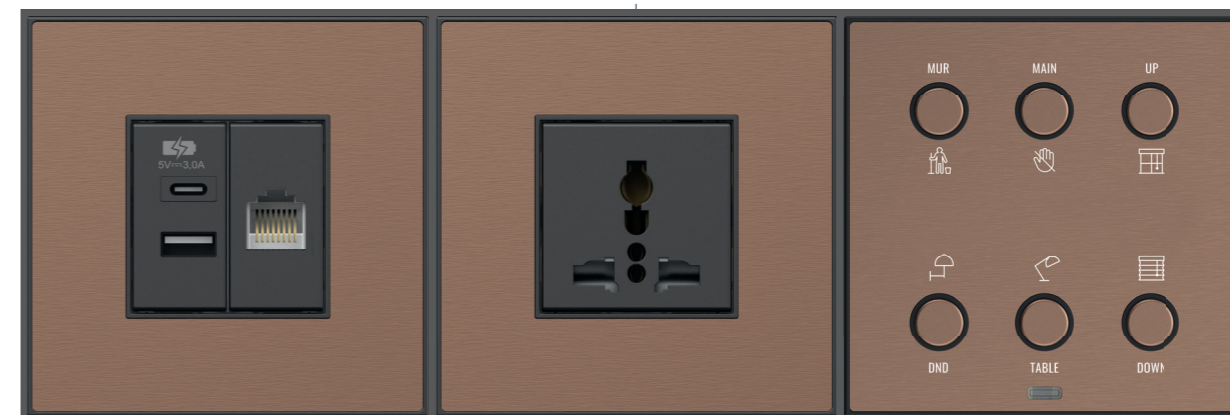

USB-A+C sockets & LAN RJ45

AC power multistandard socket PMS

Metal switch buttons with indicators

The Icon Configurator for iNELS controllers is a software tool that allows users to customise and personalise the icons used on their iNELS controllers. With this tool, users can choose from a variety of pre-designed icons to suit their specific needs. The Icon Configurator is a powerful tool that gives users complete control over the look and feel of their iNELS control systems, allowing them to create a truly unique and customised user experience.

The features and benefits of the iNELS Icon Configurator for controllers

The iNELS Icon Configurator for controllers offers a range of features that allow for a highly customized user interface. With this tool, users can create personalized icon control buttons in just a few minutes, enabling the creation of good-looking UI's with minimal effort. This customization capability allows for a more tailored user experience, as the interface can be designed to meet the specific needs of the user or application. With the ability to customize the user interface, users can create a control system that is both functional and aesthetically pleasing. One of the key benefits of the configurator is its easy and intuitive configuration process. This intuitive interface makes it easy for users to configure the system without the need for extensive technical knowledge or training.

Choice controller

In the first step, select the driver variant.

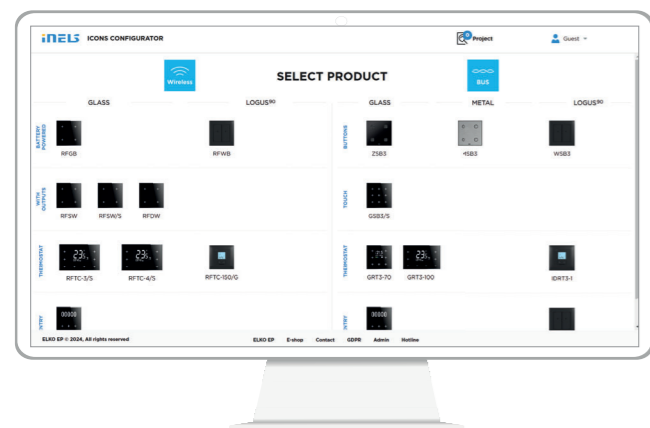

Icons settings

In the second step, we will be shown the quantity that we can use.

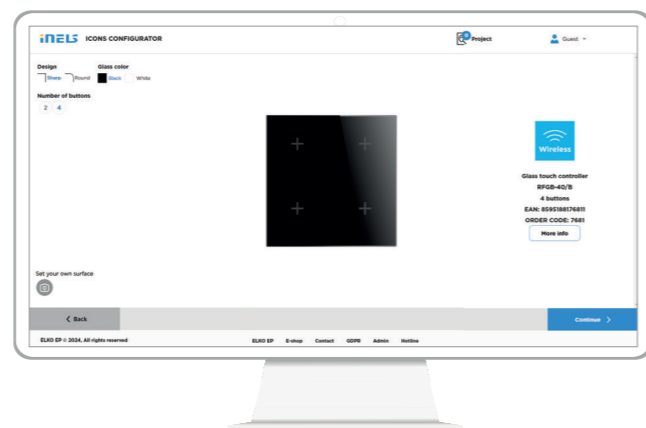

Choice icons

In the third step, you place the icons on the controller according to your preferences.

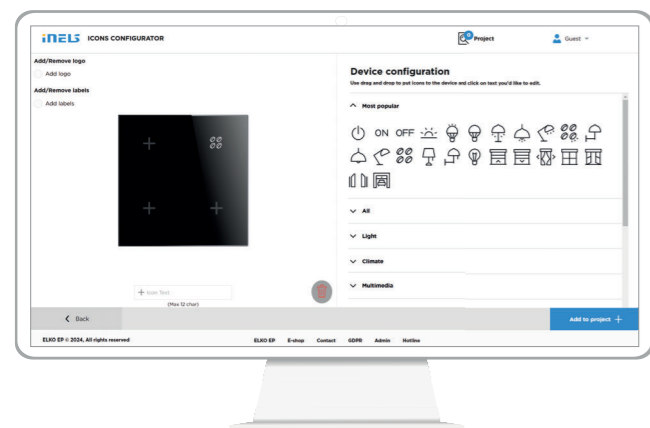

Icon name

In the last step, we can choose any name we want under the icon on the controller.

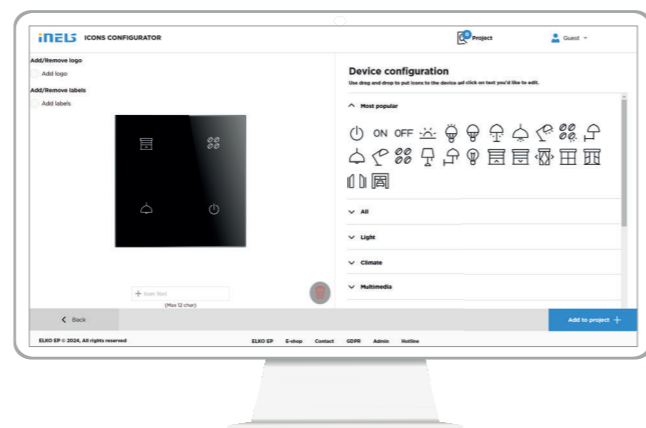

Create your glass design here: icons.inels.com

Standard symbols for laser on plastic key and glass panel

	A	B	C	D	E	F	G	H	I	J	K	L
1	⏻	⏻	⊗	⊕	⊖	×	+	—	⚙️	ON	OFF	☯️
2	^	∨	△	▽	≡	≡	<	>	◀	▶	⏪	⏩
3	☁️	☀️	☀️	☀️	☀️	💡	💡	💡	💡+	💡-	💡	💡
4	☔	☔	💡	☔	☕	☔	☔	🔔	AUTO	☐	📶	
5	☔	☔	💡	☔	☕	☔	☔	💡	☔	☔	💡	💡
6	🪟	🪟	🪟	🪟	🪟	🪟	🪟	🪟	🪟	🪟	🪟	🪟
7	🪟	🪟	🪟	🪟	🪟	🪟	🪟	🪟	🪟	🪟	🪟	🪟
8	🚗	🚗	🪟	🪟	🪟	🪟	🏠	🛏	☕	🐻	👔	📖
9	🔨	🍸	🍷	🌸	☔	👕	🚿	🚽	🏠	🔧	🍴	🚿
10	👤	👤	👤	👤	☕	👤	👤	👤	👤	👤	👤	👤
11	🔥	🔥	°C	°F	°C	°C	°C	°C	°C	°C	°C	☀️
12	🌀	🌀	🌀	🔥	🌿	🌿	❄️	🔄	🔄	🔄	💧	🔥
13	🧘	🧘	✈️	🧳	📺	📺	📺	📺	📺	📺		
14	❤️	📺	📺	(+)	🔑	🔑	🔑	🔑	🔑	🔑		
15	🔔	🔔	🔒	🔒	📺	📺	📺	📺	📺	📺		
16	🔇	🔊	🔊	🔊	🎵	📞	📞	📞	ECO	🔊	🔊	
17	☐	☐	☐	☐	☐	☐	☐	☐	☐	☐	☐	☐



EAN code	
IDRT3-1 white:	8595188149488 (device, cover)
IDRT3-1 ivory:	8595188179614 (device, cover)
IDRT3-1 ice:	8595188179591 (device, cover)
IDRT3-1 pearl:	8595188179621 (device, cover)
IDRT3-1 aluminium:	8595188179584 (device, cover)
IDRT3-1 gray:	8595188179607 (device, cover)

Technical parameters IDRT3-1

Inputs	
Temperature measuring:	YES, built-in thermo sensor
Range/accuracy of temp. measuring:	0 to +55 °C; 0.3 °C from range
Heating/cooling circuit correction:	±3, ±4 or ±5 °C
Manual control of heating/cooling circuit:	2 x buttons
External temperature sensor:	YES, the connection between AIN1/DIN1 and AIN2/DIN2
Type of external sensor:	TC/TZ
Temperature measurement range:	-20 °C to +120 °C
Temperature measurement accuracy:	0.5 °C from range
Communication	
Installation:	BUS
Display:	symbol display
Backlight:	YES
Power supply	
Supply voltage/tolerance:	27 V DC, -20/+10 %
Dissipated power:	max. 0.5 W
Rated current:	20 mA (at 27 V DC), from BUS
Connection	
Terminals:	0.5 - 1 mm ²
Operating conditions	
Operating temperature:	0 to +50 °C
Protection degree:	IP20
Overvoltage category:	II.
Pollution degree:	2
Operation position:	vertical, downward with BUS terminal
Installation:	into installation box
Dimensions and weight	
Dimensions	
- plastic:	85.6 x 85.6 x 50 mm
- metal, glass, wood, granite:	94 x 94 x 50 mm
Weight:	76 g (without frame)
Standards:	EN 63044-1

- IDRT3-1 is a digital wall temperature controller used to regulate the temperature in a room.
- Using the IDRT3-1, it is possible to correct the given heating/cooling circuit within a range of ±3, ±4 or ±5 °C (optional in SW iDM3).
- The temperature controller is equipped with an integrated heat sensor used to measure the room temperature. It is also equipped with two analog digital inputs (AIN/DIN), which can be used to connect two potential free contacts or a single external temperature sensor TC/TZ (e.g. for measuring the floor temperature).
- The display shows the current temperature and after pressing one of two buttons under the display, you can control the desired temperature.
- Readability improves after pressing one of the buttons to activate the backlight.
- Heating/cooling circuit is assigned with a thermo-regulator using iDM3.
- In the case of temperature correction within ±3, ±4 or ±5 °C, this change is valid until the next time mark within the time schedule established in iDM3.
- IDRT3-1 in design LOGUS⁹⁰ is intended for mounting into an installation box.

Connection

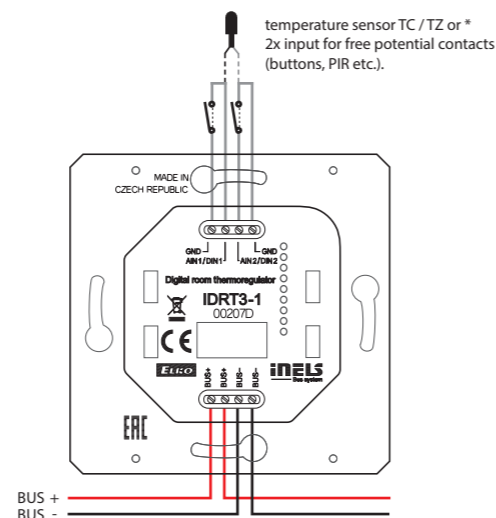

*The choice is made in iDM3 for each unit separately.



EAN code	Order Code:
GRT3-70/B: 8595188191548	GRT3-70/B: 9154
GRT3-70/W: 8595188191531	GRT3-70/W: 9153
GRT3-270/B: 8595188191562	GRT3-270/B: 9156
GRT3-270/W: 8595188191555	GRT3-270/W: 9155

The picture of device is illustrative, the icons (symbols) are configurable by the customer.

Technical parameters GRT3-70 GRT3-270

Inputs	
Temperature measuring:	YES, built-in temperature sensor
Scope and accuracy of temp. measurement:	0 to +55 °C; 0.3 °C from the range
Humidity measurement:	YES
Humidity measurement range:	0 to 99 % RH
Humidity measurement accuracy:	± 3 % relative humidity
Inputs:	1x AIN/DIN
Resolution:	by setting 10-bit
External temperature sensor:	YES, the connection between AIN1/DIN1 and AIN2/DIN2
Type of external sensor:	TC/TZ
Temperature measurement range:	-20 °C to +120 °C
Temperature measurement accuracy:	0.5 °C from the range
Buttons	
Number of control buttons:	7
Type:	capacitive
Indication:	coloured illuminated symbol
Display	
Display:	colored TFT, 26 x 26 mm
Resolution:	240 x 240 pixels
Outputs	
Acoustic output:	piezo-changer
Communication	
Installation BUS:	BUS
Power supply	
Supply voltage/tolerance:	27 V DC, -20/+10 %
Dissipated power:	max. 0.5 W
Rated current:	85 mA (at 27 V DC), from BUS
Connection	
Terminals:	0.3 - 0.8 mm ²
Operating conditions	
Relative humidity:	max. 80 %
Operating temperature:	-20 to +55 °C
Storing temperature:	-30 to +70 °C
Protection degree:	IP20
Overvoltage category:	II.
Pollution degree:	2
Operation position:	any
Installation:	on the wall, observing the conditions for correct installation of the thermostat
Dimensions and weight	
Dimensions:	94 x 94 x 41 mm 100 x 100 x 8 mm
Weight:	156 g
Standards:	EN 63044-1

Create your glass design here:
icons.inels.com



- Glass room thermo-regulator GRT3-70 is part of a comprehensive range of glass iNELS control units for apartments, guest room management system (GRMS) and serves to regulate the temperature in the room.
- Comes with bigger display and new design compared to the previous version GRT3-50.
- GRT3-70 thermo-regulator has a display for displaying the current room temperature and desired temperature. To adjust the required temperature, it is possible to use the touch buttons with symbols "-" and "+".
- GRT3-70 is also suitable for controlling fan coils and fan speed can be easily adjusted by using the touch buttons with symbols.
- Thermo-regulator GRT3-70 also features its touch buttons whose function can be adjusted by software, for example fan coil on/off, heating/cooling or comfort temperature for heating or cooling.
- Thermo-regulator is equipped with an integrated temperature sensor for ambient temperature measurement.
- The glass room thermo-regulator is a design component of the iNELS system and is available in elegant black (GRT3-70/B) and white (GRT3-70/W) version.
- Engraving of symbols is possible upon a request.
- Individual symbols can be illuminated.
- GRT3-70 are designed for mounting into an installation box.
- Custom icon and button configuration icons.inels.com

Other variants

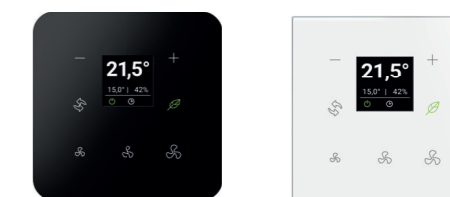

GRT3-70/B

GRT3-70/W

Connection

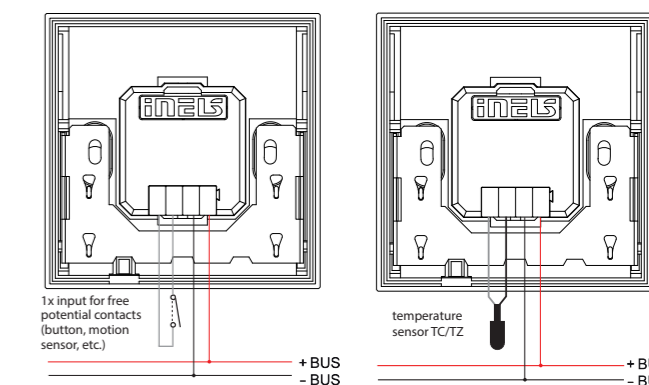

Another view



GRT3-70/W

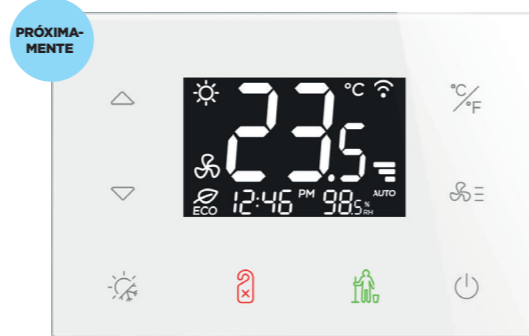

EAN code: GRT3-100/W: 8595188191746, GRT3-100/B: 8595188191739
 Order Code: GRT3-100/W: 9174, GRT3-100/B: 9173
 The picture of device is illustrative, the icons (symbols) are configurable by the customer.

Technical parameters	GRT3-100/B	GRT3-100/W
Power supply		
Power supply voltage:	110 - 230V AC, 50-60Hz, L and N terminals	
Apparent/loss power input:	5 VA/3 W	
Supply voltage tolerance:	± 10%	
Outputs		
Relays:	5x switching / 5A / 250V AC1 / 1385VA	
Contact life:	mechanical: 10 mil. / electrical 100.000 switches	
Analog Output:	2x 0-10V, 10 mA	
Inputs (external)		
Binary:	1x potential-free contact, terminals IN1/IN2 against GND, maximum wire length 30m	
Temperature:	1x for external temperature sensor TC/TZ, terminals IN1/T & IN2/TC, temperature range -20 to +120 °C, accuracy ± 0.5 °C	
Sensors (internal)		
Temperature:	range 0 to +55 °C, accuracy ± 0.5 °C from the range	
Humidity:	0 - 99% RH, accuracy ± 3 °C from the range	
Proximity:	backlight activation when zooming <25 cm	
Lighting:	adaptive backlight control of the display and buttons	
Communications		
iNELS BUS:	BUS	
Control and display		
Display:	LCD (VA/TN), active area 54x34mm	
Buttons:	8x, capacitive, backlit	
Connection		
Terminals (BUS):	0.2 - 1.5 mm ²	
Terminals (relay):	min. 0.2 mm ² /max 1.5 mm ² with sleeve	
Terminals block:	16 pole, screwless (push-in)	
Mechanics		
Operating temperature:	- 0 to 50 °C / max 90% RH	
Storage temperature:	- 20 to 60 °C	
Enclosure:	IP30 (mounted)	
Overvoltage category:	II.	
Pollution degree:	2	
Working position:	horizontal	
Installation:	on EU or British box with 60 mm bolt spacing	
Dimension:	120x80x27 mm	
Weight:	230g	
Shape/edges:	sharp	
Color (glass and plastic)	White	Black
Standard:	EN 63044-1	

- Glass room thermo-regulator GRT3-100 is part of a comprehensive range of glass iNELS control units for apartments, guest room management system (GRMS) and serves to regulate the temperature in the room.
- The glass room thermo-regulator is a design component of the iNELS system and is available in elegant black (GRT3-100/B) and white (GRT3-100/W) version.
- GRT3-100 thermo-regulator has a display for displaying the current room temperature and desired temperature. To adjust the required temperature, it is possible to use the touch buttons with symbols "−" and "+".
- The GRT3-100 is equipped with 5x 8 A relay output for fan speed and valves. It is also equipped with analog-to-digital input (AIN/DIN), which can be used to connect potential-free contact or external temperature sensor TC/ TZ (for example temperature measurement of the room or floor).
- GRT3-100 is also suitable for controlling fan coils and fan speed can be easily adjusted by using the touch buttons with symbols.
- Thermo-regulator GRT3-100 also features its touch buttons whose function can be adjusted by software, for example fan coil on/off, heating/cooling or comfort temperature for heating or cooling.
- Thermo-regulator is equipped with an integrated temperature sensor for ambient temperature measurement.
- Printing is possible to customize to the investor requirements.
- Individual symbols can be illuminated in one of seven colours - red, green, blue, yellow, pink, turquoise and white.
- GRT3-70 units are designed to be mounted in a mounting box.
- Custom icon and button configuration icons.inels.com

Options: external temperature sensors

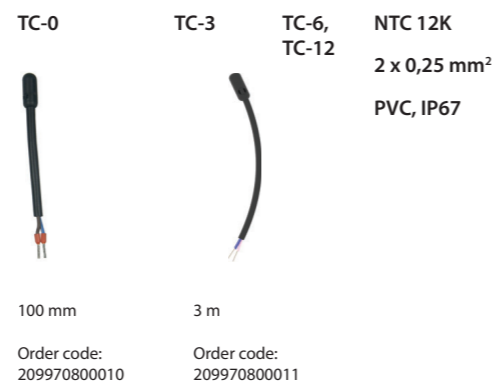

Buttons and display description

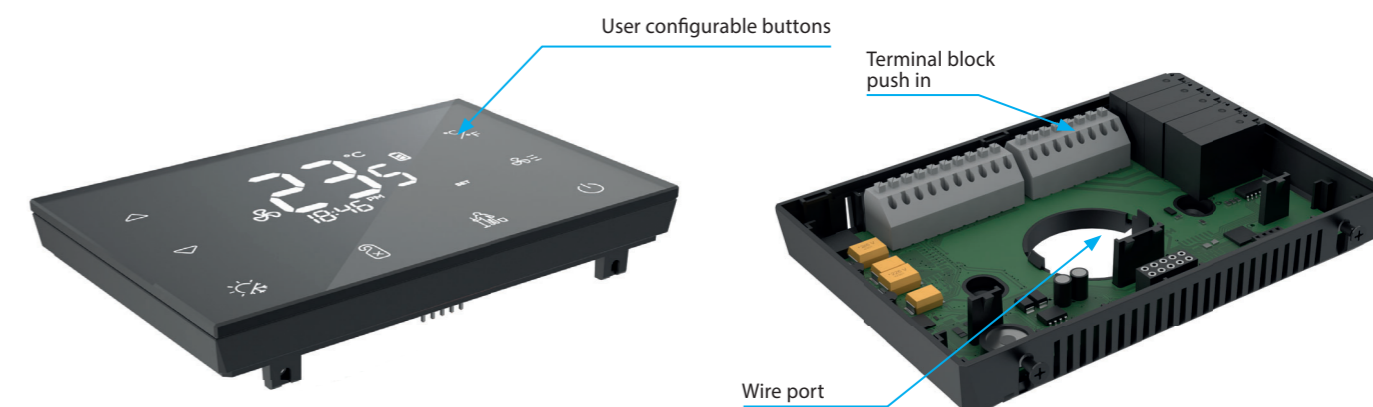

Connection

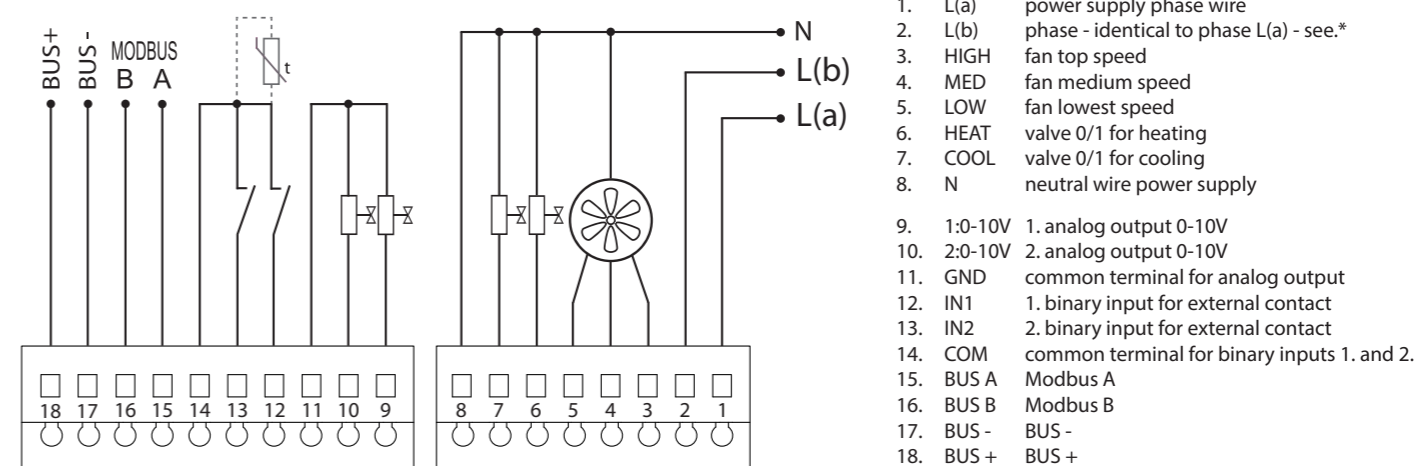

Option for an external temperature sensor TC/TZ

- | | |
|---------|-----------------------|
| 12. IN1 | temperature input NTC |
| 13. IN2 | temperature input NTC |

* in the case of an auxiliary heater, it is connected to terminals 6 or 7 (max. 1500 W).

Another view



GRT3-100/W



GRT3-100/B

Create your glass design here:
icons.inels.com



What is MQTT?

(Message Queuing Telemetry Transport)



MQTT (Message Queuing Telemetry Transport) is a communication protocol designed for efficient and reliable data transmission between devices or applications over a network. It was developed for use in situations where messages need to be sent with minimal overhead and low latency, which is crucial in limited or unstable network conditions, such as the Internet of Things (IoT) or mobile networks.

The main features of MQTT

- 1. Publish-Subscribe Model:** MQTT utilizes the "publish-subscribe" model, where clients can publish messages on specific topics, and other clients subscribed to these topics can receive the messages. This model provides a decentralized way of communication and allows a larger number of devices (subscribers) to respond to events from various publishers.
- 2. Low Data Overhead:** The MQTT protocol is designed with efficiency and low data overhead in mind. The message header is very small, reducing bandwidth demands and enabling efficient data transmission even on resource-constrained devices, such as sensors or microcontrollers.
- 3. QoS (Quality of Service):** MQTT allows you to set the level of quality of service for message delivery according to the application's needs. There are three QoS levels:
 - **QoS 0:** It provides "at most once" message delivery, meaning messages may be lost, but they are transmitted with minimal overhead.
 - **QoS 1:** It ensures "at least once" message delivery, but there may be instances of duplicate delivery.
 - **QoS 2:** It guarantees "exactly once" message delivery, which is the most reliable level but requires the most overhead.
- 4. Retained Messages:** MQTT allows the broker to retain the last message on a specific topic. When a new client subscribes to that topic, it immediately receives this retained message. This is useful, for example, in situations where we want to obtain the current state of a device after it connects.
- 5. Easy Connection:** MQTT is designed to make it easy to connect to a broker and start publishing or subscribing to messages. MQTT client implementations are available for various platforms and programming languages, making it easy to integrate them into different applications.
- 6. Broad Support:** MQTT is supported by a wide range of devices and platforms, making it an ideal choice for communication in IoT environments and other applications that require reliable and low-overhead communication.

Thanks to these features, MQTT has become a popular protocol for communication in IoT, sensor networks, telemetry, tracking systems, and other applications where efficient and reliable data transmission over the network is crucial.

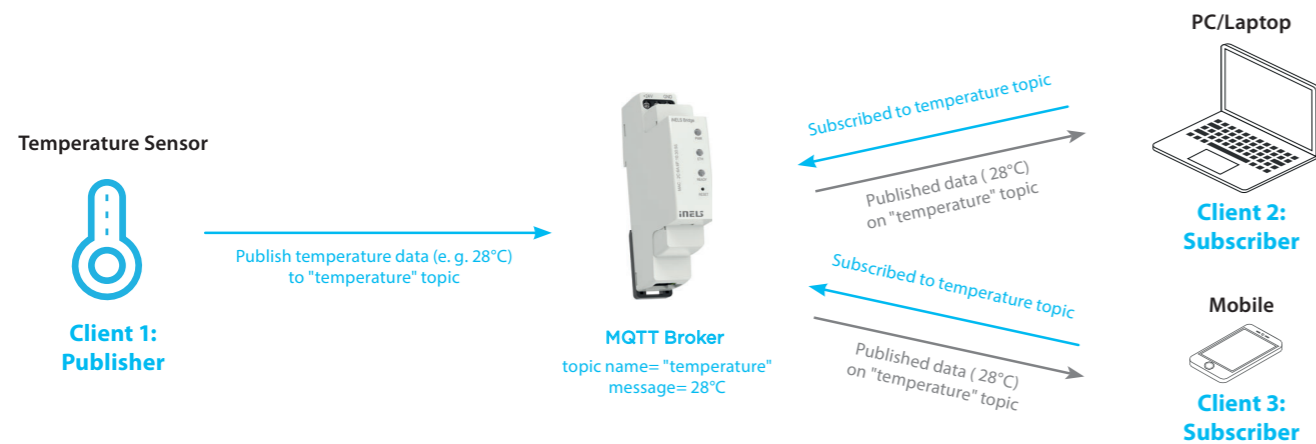

iNELS supports MQTT

The iNELS gateways, both in wired (CU3-07/08M) and wireless (eLAN-RF-103) versions, have implemented bidirectional MQTT communication. In practice, this means that real-time data from all iNELS system components are sent to the MQTT Broker (iNELS Bridge). Additionally, thanks to the bidirectional communication, these components can be freely controlled.

This approach makes the iNELS system open for easy integration into superior BMS (Building Management Systems) and PMS (Property Management Systems). It can be easily connected to third-party systems and implemented into various applications.

iNELS Bridge

Home Assistant

The revolutionary iNELS Bridge device is unique in that it combines several technologies. Its core feature is the pre-installed MQTT Broker, a software platform that will receive, store, and mediate all MQTT communication within one or even multiple installations.

Home Assistant is a popular environment for creating and managing all automation systems. In this environment, users or administrators can create their own scenarios or automations across different technologies within the property. An integral part of this is a user-friendly application for mobile platforms or computers.

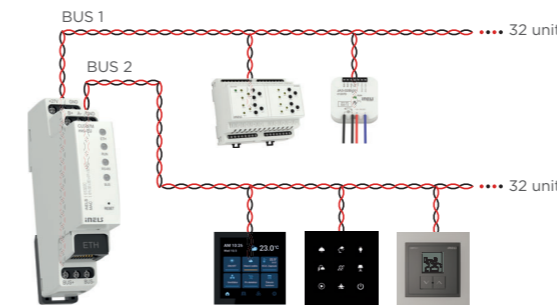

Central unit

iNELS Bridge

eLAN Gateway



MQTT Broker



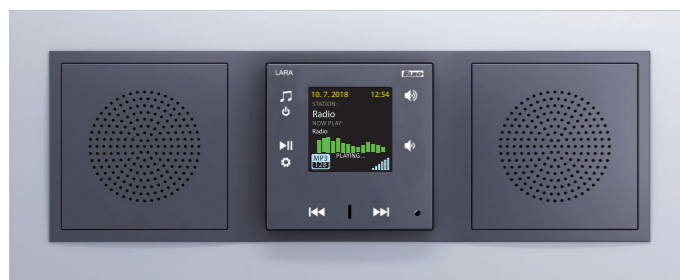
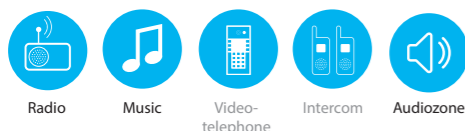

Technical parameters		LARA Radio
Internet Radio		
Supported data transfer formats:	mp3, ogg, acc	
Control/Settings		
Front panel:	touchscreen buttons	
Communication Ethernet:	via PC setting up and communicating SW LARA Configurator	
Button RESET:	restart product/ reset product to factory settings	
Interface ethernet		
Communications interface:	10/100 Mbps	
Connector:	RJ45	
Max. cable length UTP with power:	50 m	
Display		
Type:	color OLED	
Resolution:	128 x 128 pixels	
Visible surface:	26 x 26 mm	
Power supply		
Supply:	Passive PoE 24 V DC/1.25 A	
Min. input:	1.4 W	
Max. input:	26 W (peak at maximum playback performance)	
Amplifier		
Amplifier:	stereophonic class D with digital output control	
Max. amplifier output:	2 x10 W/8 Ω	
Inputs/Outputs		
Microphone:	NO	
Audio input:	3.5 stereo jack	
Audio output 1:	terminals LINE OUT (used for external amplifier)*	
Audio output 2:	terminals OUT L/OUT R (speaker output from int. amplifier)	
Connection		
Terminal block:	0.5 - 1 mm ²	
Other data		
Working temperature:	0 to + 55 °C	
Protection degree:	IP20	
Overvoltage category:	II.	
Pollution degree:	2	
Installation:	in an installation box	
Dimensions and weight		
Dimensions:		
- plastic:	85 x 85 x 46 mm	
- metal, glass, wood, granite:	94 x 94 x 46 mm	
Weight:	209 g (plastic frame)	
Standard:	EN 63044-1, EN 62368-1	

- A music and internet radio player - all in the dimension of a switch and a luxurious LOGUS⁹⁰ design.
- LARA Radio - when connected to the Internet, it can play streaming radio stations and you can store up to 40 of them. But you can also select from thousands of radio stations from across the globe, which provide data for correct connection.
- LARA Radio can play content from an external music source, which can be a smart phone or e.g. an MP3 player. These devices are connected to a 3.5mm stereo jack audio input, located underneath the front panel.
- Touch control is performed on the device front panel (six capacity buttons available), or LARA Dio.
- The basic device settings (network connection, language, audio input) are performed via the display and a simple menu controlled from capacity buttons on the device front cover. Further settings (selection of stations, connection with the server, updating firmware, etc.) are configured via computer and the software LARA Configurator.
- LARA Radio is equipped with an OLED colored display with the size of 1.5". The display also shows basic information about playing music, which also serves the orientation in the menu settings, etc.
- LARA Radio has an integrated amplifier with 2x 10 W output, thus greatly facilitating device installation in places where such output suffices. LARA is used e.g. to provide premium sound to the kitchen, bathrooms, waiting rooms, offices, reception desks, entrance halls, operating rooms or wellness facilities.
- LARA is powered by PoE with maximum voltage level 27 V DC/ 1000 mA. So connecting and communicating with just one cable (UTP) is a major advantage.
- For LARA, an entire series of accessories is ready for connection (PoE adapters, PoE switches), speakers (in a frame, walls or ceilings) and installation (cables, box, etc.).
- Complies with standards IEEE 802.3u (100BASE-Tx).
- Automatic cable crossing detection of Ethernet cable - MDIX.

EAN code
 LARA Radio white: 8595188148719
 LARA Radio ivory: 8595188149242
 LARA Radio ice: 8595188149228
 LARA Radio pearl: 8595188149259
 LARA Radio aluminium: 8595188149211
 LARA Radio grey: 8595188149235

* The cable from the LINE OUT terminals must be shielded, max. length should not exceed 5 m.

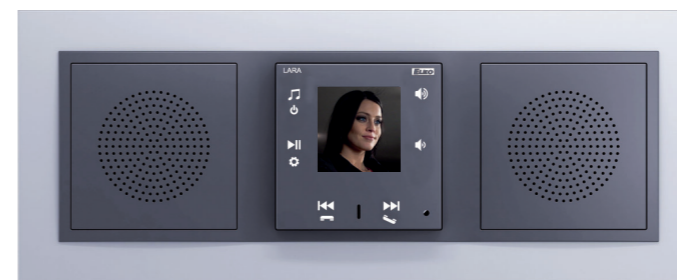
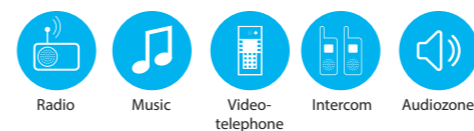

Technical parameters		LARA Intercom
Internet Radio		
Supported data transfer formats:	mp3, ogg, acc	
Control/Settings		
Front panel:	touchscreen buttons	
Communication Ethernet:	via PC setting up and communicating SW LARA Configurator	
Button RESET:	restart product/ reset product to factory settings	
Interface ethernet		
Communications interface:	10/100 Mbps	
Connector:	RJ45	
Max. cable length UTP with power:	50 m	
Display		
Type:	color OLED	
Resolution:	128 x 128 pixels	
Visible surface:	26 x 26 mm	
Power supply		
Supply:	Passive PoE 24 V DC/1.25 A	
Min. input:	1.4 W	
Max. input:	26 W (peak at maximum playback performance)	
Amplifier		
Amplifier:	stereophonic class D with digital output control	
Max. amplifier output:	2 x10 W/8 Ω	
Inputs/Outputs		
Microphone:	YES	
Audio input:	3.5 stereo jack	
Audio output 1:	terminals LINE OUT (used for external amplifier)*	
Audio output 2:	terminals OUT L/OUT R (speaker output from int. amplifier)	
Connection		
Terminal block:	0.5 - 1 mm ²	
Other data		
Working temperature:	0 to + 55 °C	
Protection degree:	IP20	
Overvoltage category:	II.	
Pollution degree:	2	
Installation:	in an installation box	
Dimensions and weight		
Dimensions:		
- plastic:	85 x 85 x 46 mm	
- metal, glass, wood, granite:	94 x 94 x 46 mm	
Weight:	209 g (plastic frame)	

* The cable from the LINE OUT terminals must be shielded, max. length should not exceed 5 m.

EAN code
 LARA Intercom white: 8595188149389
 LARA Intercom ivory: 8595188149419
 LARA Intercom ice: 8595188149396
 LARA Intercom pearl: 8595188149426
 LARA Intercom aluminium: 8595188149372
 LARA Intercom grey: 8595188149402

- LARA Intercom offers users 5 different functions and expands even more options to Lara Radio - music players and internet radio stations within the range of LOGUS⁹⁰ switch designs.
- LARA Intercom provides an extra functionality and videophone intercom.
- Thanks to videophone function, now it is possible to have a voice communication between LARA and the sound of the door (IP Intercom), so with someone visiting and standing in front of the house, we can see that on LARA display as part of this function which increases the security feeling and safety besides of course, the comfort for the user.
- LARA Intercom is equipped with an OLED colored display with the size of 1.5", which is used to transfer images and sounds from the door camera properly. The display also shows basic information about playing music, which also serves the orientation in the menu settings, etc.
- The intercom function can also be used for communications between all the family members throughout the whole house, thanks to two way voice communications possibilities between different LARA units.
- LARA Intercom continues to offer three functions that are also supported by LARA Radio - when connected to the Internet, it can play streaming radio stations and you can store up to 40 of them. But you can also select from thousands of radio stations from across the globe, which provide data for correct connection.
- LARA Intercom can play content from an external music source, which can be a smart phone or e.g. an MP3 player. These devices are connected to a 3.5mm stereo jack audio input, located underneath the front panel. You can also use LARA for streaming your favorite music from Spotify Premium.
- Touch control is performed on the device front panel (six capacity buttons available), or LARA Dio.
- The basic device settings (network connection, language, audio input) are performed via the display and a simple menu controlled from capacity buttons on the device front cover. Further settings (selection of stations, connection with the server, updating firmware, etc.) are configured via computer and the software LARA Configurator.
- LARA Intercom has an integrated amplifier with 2x 10 W output, thus greatly facilitating device installation in places where such output suffices. LARA is used e.g. to provide premium sound to the kitchen, bathrooms, waiting rooms, offices, reception desks, entrance halls, operating rooms or wellness facilities.
- LARA is powered by PoE with maximum voltage level 27 V DC/ 1000 mA. So connecting and communicating with just one cable (UTP) is a major advantage.
- For LARA, an entire series of accessories is ready for connection (PoE adapters, PoE switches), speakers (in a frame, walls or ceilings) and installation (cables, box, etc.).
- Complies with standards IEEE 802.3u (100BASE-Tx).
- Automatic cable crossing detection of Ethernet cable - MDIX.

Specification LARA

Touchscreen operation

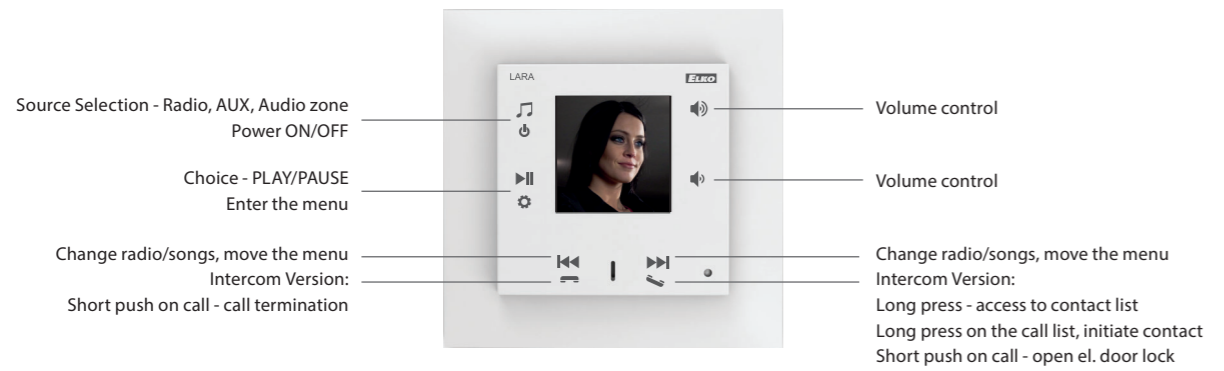

Applications control

Operations, using the application for, LARA Dio and iNELS Home Control for Android and iOS smartphones and tablets.

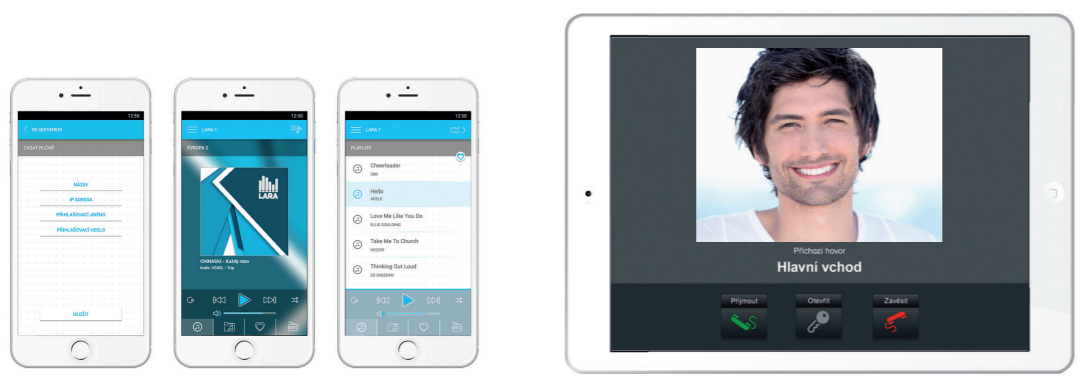

Wiring example

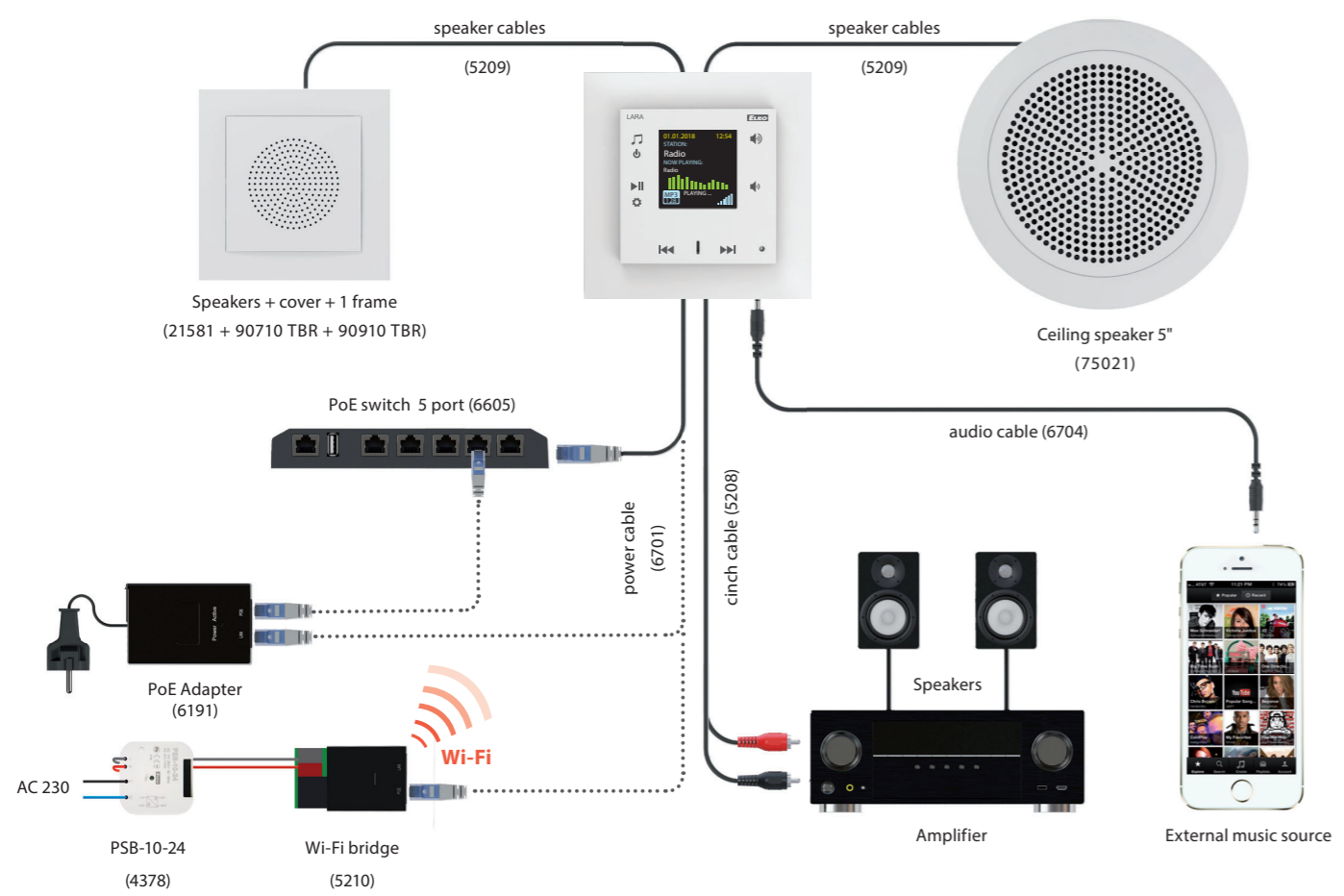

Accessories LARA

Speakers and cables

- AUX CABLE LARA (LARA CINCH CABLE)** (5208)
Used to connect LARA with exter. amplifier. Reduction 4pin from LARA LINE OUT to 2x CINCH plug into amplifier, length 2 x 20 cm.
- POWER SUPPLY (PSB-10-24)** (4378)
Switching stabilized power supplies with fixed output voltage, intended for mounting into an installation box (e.g. KU-68). PSB-10-24 - stabilized power supply 24V/10 W.
- AUX CABLE LARA (LARA AUDIO CABLE)** (6704)
Used to connect LARA with external music source (smart phone mp3 player). The length is 20 cm terminated with 2x stereo jack 3.5 mm.
- CEILING SPEAKER** (75021 CBR)
Speaker is suitable for the installation in suspended ceilings and hollow walls. Mounting hole diameter 143 mm, Power 8 W, 32 Ω speaker impedance.
- SURFACE SPEAKER** (75106 CBR)
Two-way speaker intended for mounting in a ceiling or on the walls: Power 15 W, 32 Ω speaker impedance, dimensions 270x183x37 mm. Color: White
- NETWORK CABLE, 0.2 m** (6702)
Flat white LAN cable CAT5, length 20 cm, terminated with 2x RJ45 plugs.
- NETWORK CABLE, 1 m** (6700)
Flat white LAN cable CAT5, length 1 m, terminated with 2x RJ45 plugs.

Installation material

- 1-FRAME** (90910 TBR)
- 2-FRAME** (90920 TBR)
- 3-FRAME** (90930 TBR)
- 4-FRAME** (90940 TBR)
- 5-FRAME** (90950 TBR)
- SURFACE MOUNT BOX** (10976 ABR)
- INSTALLATION BOX 1 GANG (KP 67/2)** (6705)
- INSTALLATION BOX 2 GANG (KP 64/2)** (6706)
- INSTALLATION BOX 3 GANG (KP 64/3)** (6707)
- INSTALLATION BOX 4 GANG (KP 64/4)** (6708)
- INSTALLATION BOX 5 GANG (KP 64/5)** (6709)
- INSTALLATION BOX 1 GANG (KP 64/LD)** (6710)
- INSTALLATION BOX 2 GANG (KP 64/2L)** (6711)
- INSTALLATION BOX 3 GANG (KP 64/3L)** (6712)
- INSTALLATION BOX 4 GANG (KP 64/4L)** (6713)
- INSTALLATION BOX 5 GANG (KP 64/5L)** (6714)
- UNIVERSAL BOX 1068-02** (6716)
- UNIVERSAL BOX KUH 1/L NA** (6717)

Power supply and network

- WI-FI BRIDGE** (5210)
Used for LARA wireless connection via WiFi network.
- PoE SWITCH - 5x RJ45** (6605)
Provides LAN connectivity and PoE power supply for up to 5 x LARA.
- PoE SWITCH - 8x RJ45** (6606)
Provides LAN and connected PoE of up to 8x LARA. In addition to the 24 V PoE also offers a 48 V PoE for the power supply of 2N.

Power sets

- POWER SUPPLY PoE + WiFi INTO OR THE BOX** (5224)
WiFi bridge with PoE and power supply into an installation box. Power supply 230 V.
- POWER SUPPLY PoE INTO A BOX** (5226)
PoE injector with power supply intended for an installation box. Power supply 230 V.
- PoE SUPPLY** (5225)
Power injector with plug-in adapter 230 V.
- POWER SUPPLY PoE + WiFi** (5227)
WiFi bridge with PoE plug in adapter 230 V.

The application allows easy control of connected devices through wireless and wired gateways, such as socket switching, dimming lights, controlling blinds or garage doors, managing heating circuits, and compatible air conditioning. It also displays available values, such as temperature, status of motion detectors, windows, doors, or flood detectors, as well as the current status of all controlled devices.

Newly, the application can be installed on tablets, where all control options are fully preserved, just like in the standard application. The user-friendly Dashboard on the tablet enables users to view frequently used devices, previews of connected cameras, and created scenes. Users can quickly and easily control multiple devices at once with a single click. Furthermore, it is now possible to integrate SIP-enabled Intercoms, allowing call notifications and door unlocking from anywhere in the world. Another new feature includes receiving notifications related to units connected to the account. With the new iNELS mobile application, we are opening a completely new stage, expanding the functions and integration possibilities of the iNELS system.

In addition to the iNELS mobile application, there is also the inels.cloud platform available. This website allows users to control devices connected to inels BUS and RF gateways through the cloud. The platform offers advanced features, including the ability to configure custom Dashboards, view historical device data, and conditionally interconnect RF and BUS units. This feature allows users to set conditions to respond to specific events or interconnect devices with each other. Another useful function is push notifications, which inform users about important events or device statuses. With the inels.cloud platform, user management is also possible, enabling account owners to add additional users and restrict their rights to control specific devices.

Thanks to these new updates and features, the iNELS mobile application and inels.cloud platform expand the possibilities and integration options of the iNELS system, providing users with an enhanced and seamless smart home experience.

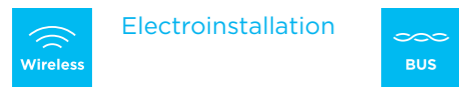

	Electroinstallation		Lighting control	•
			Garage doors and gates	•
			Switching appliances	•
			RGB bulbs and LED strips	•
			Detectors/sensors	•
	HVAC	Heating	•	
		Air conditioning	•	
		Recuperation	•	
	3rd party	Cameras	•	
		Weather station	•	
		Intercoms	•	
	Voice assistants	Home appliances	•	
		Google Home	•	
	Others	Amazon Alexa	•	
		Automation	•	
		Notification	•	
		Favourites/overview	•	
		Log history	•	
			Weather data	•
			Users management	•



Conditions

Unlimited automation options.

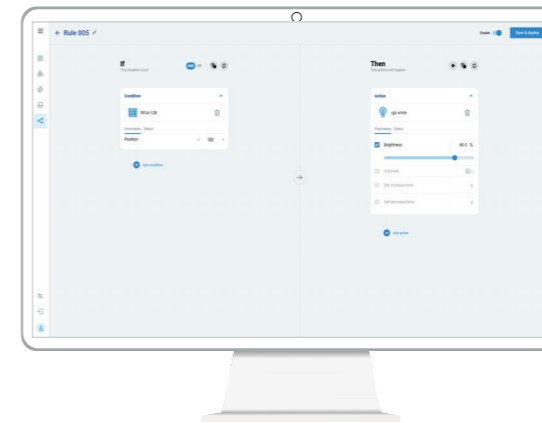

User management

Control of user accounts.

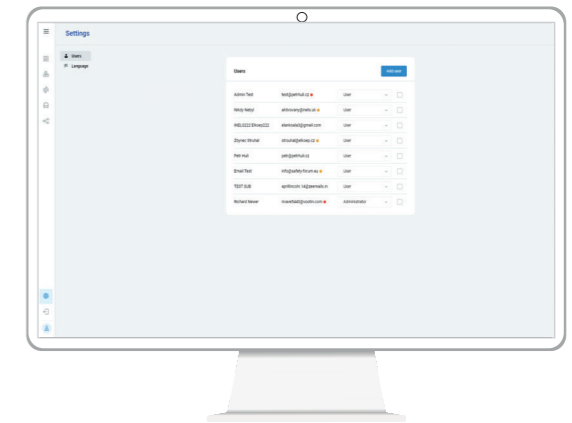

Dashboard

Device overview with the option to view event history.

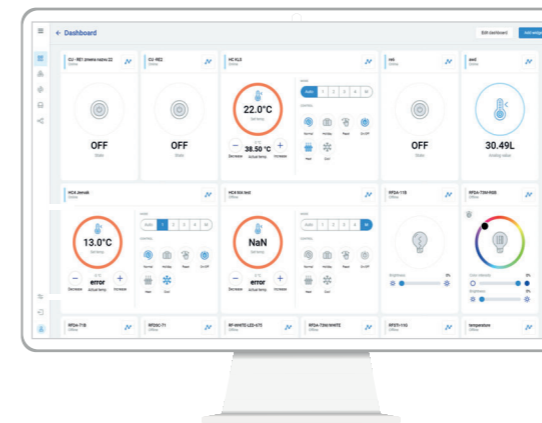

Scenes

Group device control.

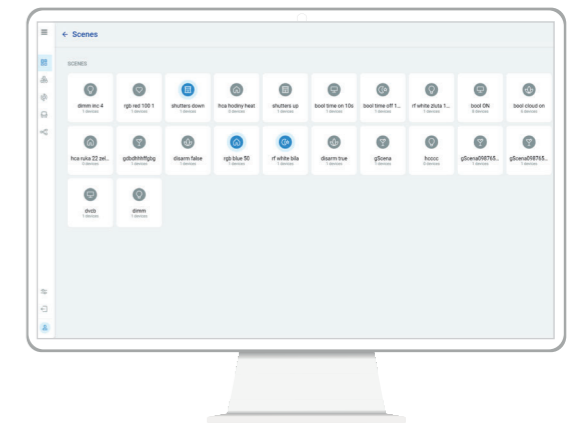

Dashboard

Absolute control over the state of all technologies.

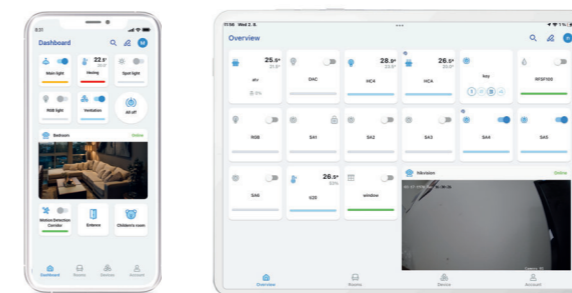

Device list

Control the device from anywhere.

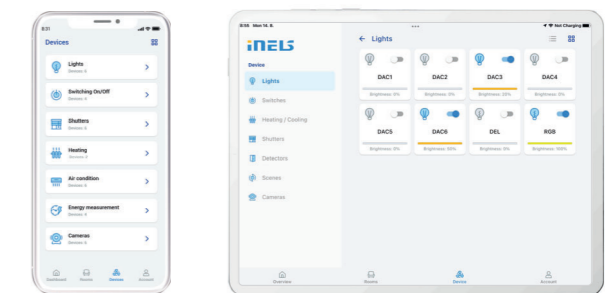

Rooms management

Settings according to individual rooms.

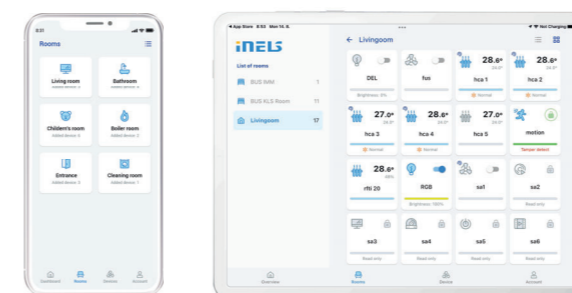

Colour setting

Easy adjustment of the light scene with one touch - switching, dimming, colour.





EAN code
Telva-2 230V, NC: 8595188181976
Telva-2 230V, NO: 8595188181969
Telva-2 24V, NC: 8595188181990
Telva-2 24V, NO: 8595188181983

Technical parameters	TELVA 230V		TELVA 24V	
	NO	NC	NO	NC
Operating voltage:	230 V, 50/60 Hz		24 V, 50/60 Hz	
Switching current max:	300 mA		500 mA	
Operating current:	13 mA		100 mA	
Closing/opening time:	3–5 min		3–5 min	
Power input:	2.9 W		2.4 W	
Protection:	IP54		IP54	
Settings:	4 mm (0.16")		4 mm (0.16")	
Stopping force:	90–110 N		90–110 N	
Cable length:	800–1000 mm (31–39")		800–1000 mm (31–39")	
Connecting wire:	2 x 0.75 mm ²		2 x 0.75 mm ²	
Media temperature:	-5 °C to 60 °C (23 to 140 °F)		-5 °C to 60 °C (23 to 140 °F)	
Colour:	white RAL 9003		white RAL 9003	
Dimensions h/w/d:	63 x 42 x 45 mm (2.5 x 1.7 x 1.8")		63 x 42 x 45 mm (2.5 x 1.7 x 1.8")	
Connection size:	M30 x 1.5 mm (1.2" x 0.06")		M30 x 1.5 mm (1.2" x 0.06")	

- ThermoDrive is intended for opening or closing valves in heating, cooling or air conditioning systems. It is also suitable for use in a floor heating or ceiling cooling manifolds.
- Available in NO (open without voltage), NC (closed without voltage) and for 230 V and 24 V.
- The internal principle of operation of thermoDrive mechanism = its movement so that the valve opens/closes is provided by an electric heating element with expansion material, which expands due to temperature changes in the supply voltage.
- ThermoDrive is maintenance-free and works completely silently.
- ThermoDrive is fitted with a metal nut M30 x 1.5, thanks to which it becomes a 100% fixed part of the valve with this corresponding thread size after installation.
- The stated nut size predetermines the use of a thermocouple with valves from manufacturers such as Herz, HoneyWell, Danfoss, Oventrop and others.

• Telva thermo drive:

- is characterized by absolutely quiet and maintenance-free operation
- is designed for installation - control of heating and cooling systems
- method of mounting the actuator on the controlled valve using an M30 x 1.5 nut
- any working position

• Type of use:

- Floor heating – the RFTC-50/G wireless controller measures the room temperature and, based on the set program, sends a command to the RFSA-66M switching element to open/close the TELVA thermo drive on the distributor.

AN-I | Internal antenna

AN-E1 | External antenna



- into plastic switchboard
- rod angle, without cable
- sensitivity 1 dB
- the internal antenna is included in the standard package

EAN code
Internal antenna AN-I: 8595188161862



- for mounting into metal switchboard
- cable length 3m
- sensitivity 5 dB
- the external antenna AN-E is supplied on request only

EAN code
External antenna AN-E: 8595188190121



EAN code
TC-0: 8595188110075 TZ-0: 8595188140591 Pt100-3: 8595188136136
TC-3: 8595188110617 TZ-3: 8595188110600 Pt100-6: 8595188136143
TC-6: 8595188110082 TZ-6: 8595188110594 Pt100-12: 8595188136150
TC-12: 8595188110099 TZ-12: 8595188110587

Technical parameters	TC	TZ	Pt100
Range:	-20 to +80 °C	-40°C to +125 °C	-30°C to +200 °C
Scanning element:	NTC 12K	NTC 12K	Pt100
Tolerance:	±(0.15 °C + 0.002[t])	±(0.15 °C + 0.002[t])	±(0.3 °C + 0.005[t])
In air/in water:	(τ0.5) ≤ 18 s	(τ65) 62 s/8 s	(τ0.5) -/7 s
In air/in water:	(τ0.9) ≤ 48 s	(τ95) 216 s/23 s	(τ0.9) -/19 s
Cable material:	PVC unshielded, 2x 0.25 mm ²	PVC	shielded silicone 2 x 0.22 mm ²
Terminal material:	polyamid	stainless steel	copper
Protection degree:	IP67	IP67	IP67
Electrical strength:	2500 VAC	2500 VAC	2500 VAC
Insulation resistance:	> 200 MΩ at 500 VDC	> 200 MΩ at 500 VDC	> 200 MΩ at 500 VDC

Types of temperature sensors:

	TC-0	TZ-0	Pt100-3
- length:	100 mm	110 mm	-
- weight:	5 g	4.5 g	-
	TC-3	TZ-3	Pt100-6
- length:	3 m	3	3 m
- weight:	70 g	106 g	68 g
	TC-6	TZ-6	Pt100-12
- length:	6 m	6 m	6 m
- weight:	130 g	216 g	149 g
	TC-12	TZ-12	Pt100-12
- length:	12 m	12 m	12 m
- weight:	250 g	418 g	249 g

τ65 (95): time, which sensor needs to heat up on 65 (95) % of ambient temperature of environment, in which is located.

Sensor photo

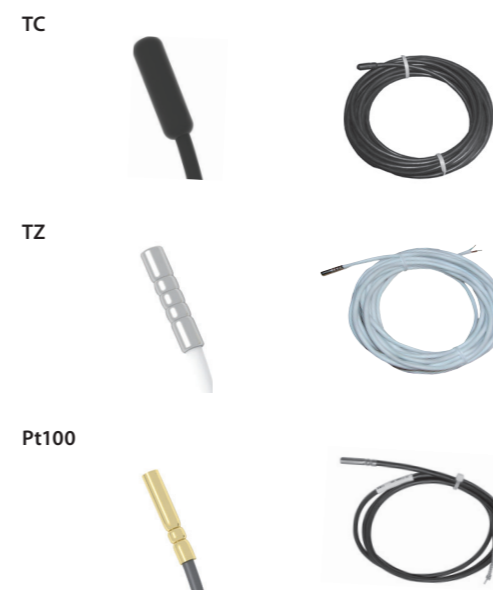

- Thermister temperature sensors are made of Negative Temperature Coefficient (NTC) embedded in a PVC or metal sleeve with a thermally-conductive sealer.
- **Sensor TC**
 - lead-in cable to sensor TC is made of wire CYSY 2D x 0.5 mm/0.02".
- **Sensor TZ**
 - cable VO3SS-F 2D x 0.5 mm/0.02" with silicone insulation for use in high temperature applications.
 - silicone insulation for use in high temperature applications.
- **Sensor Pt100**
 - shielded silicon 2x 0.22 mm² (AWG 21), shielding connected with a case.
 - temperature sensors can be connected directly to the terminal block
 - cable lengths can not be changed, connected or modified.

Resistive values of sensors in dependance on temperature

Temperature (°C)	Sensor NTC (kΩ)	Sensor Pt100 (Ω)
20	14.7	107.8
30	9.8	111.7
40	6.6	115.5
50	4.6	119.4
60	3.2	123.2
70	2.3	127.1

Tolerance of sensor NTC 12 kΩ is ± 5% by 25 °C/77 °F.
Long-term resistance stability by sensor Pt100 is 0.05% (10 000 hours).

Diagramm of sensor warm up via air

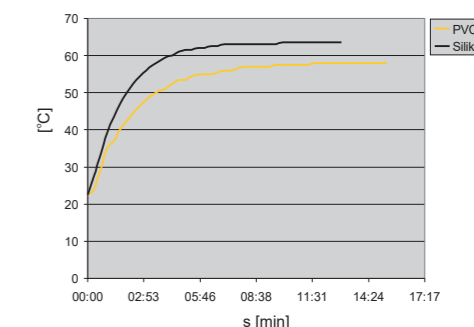

PVC - reaction to water temperature from 22.5 °C to 58 °C.
Silicone - reaction to water temperature from 22.5 °C to 63.5 °C.

Drawing

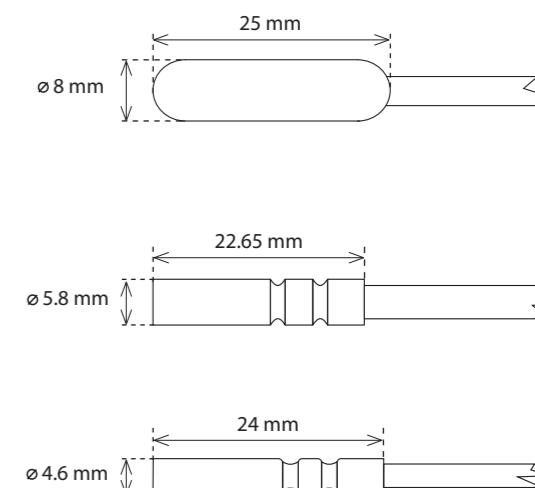



Inspiration for your living space.



Inspiration for your living space.

Inspiration for your living space.



INSPINIA

iNELS, in partnership with Inspinia, introduces the new touch control panels. These models, including INS4SQ, INS8SQ, and INS10SQ come in 4, 8, and 10-inch displays respectively.

Designed to deliver top-notch smart touch technology, these panels are equipped with the Skythings framework, which operates on Linux or Android systems. Skythings is integral to smart home, building management, and energy management solutions, providing extensive capabilities for integrators through its cloud-based Skyplatform.



More about Inspinia >

www.elkoep.com/touch-unit-inspinia



- The INS4SQ, INS8SQ, and INS10SQ are part of the Inspinia Touch Series, which are advanced touch control panels designed for smart home and building management systems.
- All three models are equipped with the Skythings framework, which can operate on either Linux or Android systems.
- This framework is essential for integrating smart home, building management, and energy management solutions.



INS4SQ

Display:	4" touch screen
Ports:	1 add-on port
Ideal for:	Apartments, flats, office rooms, hotel rooms

INS8SQ

Display:	8" touch screen
Ports:	2 add-on port
Ideal for:	Larger spaces requiring enhanced control

INS10SQ

Display:	10" touch screen
Ports:	2 add-on port
Ideal for:	High-end residential and commercial applications



Technical parameters		INS4SQ
Hardware / Software		
Hardware:	ARM A7 Single-Core 1.2 GHz / 128MB DDR3 Ram / 256 MB Nand flash	
Software:	OS Linux 3.4	
Display		
Type:	IPS 4" 480 x 480 resolution	
Display:	400 cd/m2 luminance	
Touch part:	5 Point capacitive touchscreen	
Power Supply		
Supply voltage/tolerance:	24VDC -or- 48 VDC In	
PoE:	POE IEEE 802.3af	
Dissipated power:	Power consumption max. 10W	
Connection		
Standard Interfaces:	(1x) LAN RJ45 10/100Mbps interface (1x) Add-On (optional interface) Port (1x) Digital Out (open collector 5V 100mA) (1x) Digital In	
Optional Interfaces		
	iNELS BUS	
	RS485 (EIA-485) (RS4)	
	Galvanic isolated RS485 Modbus (A-GMD)	
	VRF mainline communication (A-VRM -or- A-VRR)	
	Zigbee 3.0 (BCU-S24-ZGB -or- BCU-POE-ZGB)	
Built-in Sensors		
Humidity sensor:	range 0% up to 100% RH	
Temperature sensor:	range -40°C up to +125°C	
Operating conditions		
Working temperature:	-10°C – +60°C	
Humidity:	5% – 90% at 25°C	
Dimensions and weight		
Dimensions:	92 x 92 x 29 mm	
Standard:	EN 63044-1, EN 62368-1	
Accessories		

- The INS4SQ offers a feature-rich and versatile solution for control and monitoring applications, with its powerful hardware, user-friendly display, and support for various interfaces and sensors. Its temperature and humidity tolerance make it a reliable choice in different operating environments.
- Featuring a high-quality 4" IPS display with a resolution of 480 x 480 and a luminance of 400 cd/m2, the INS4SQ offers crisp and clear visuals for an excellent user experience.
- The device runs on Linux 3.4 operating system supporting up to 200 UI objects and 1000 BMS points.
- Equipped with an ARM A7 Single-Core 1.2 GHz processor, 128MB DDR3 RAM, and 256MB Nand flash, ensuring reliable performance for various applications.
- Integrated with essential sensors, the device includes a humidity sensor with a range of 0% up to 100% RH and a temperature sensor covering a range from -40°C up to +125°C, enabling efficient environmental monitoring.
- The INS4SQ comes with a standard LAN RJ45 10/100Mbps interface, ensuring easy network connectivity for data transfer and communication.
- The INS4SQ offers a variety of optional interfaces for enhanced connectivity and compatibility. These include iNELS, RS485, Modbus, VRF, and Zigbee 3.0
- The INS4SQ operates within a working temperature range of -10°C to +60°C.
- The device can be powered by either 24VDC or 48VDC input, and it also supports Power over Ethernet (POE IEEE 802.3af), providing flexibility in power options.
- Configuration, programming and update applications over the Skythings platform.

Connection

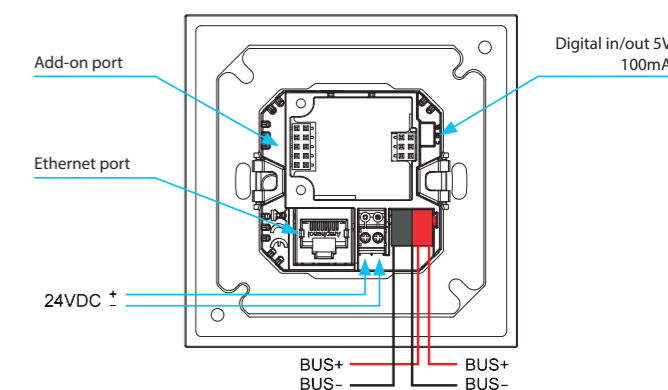

Another view

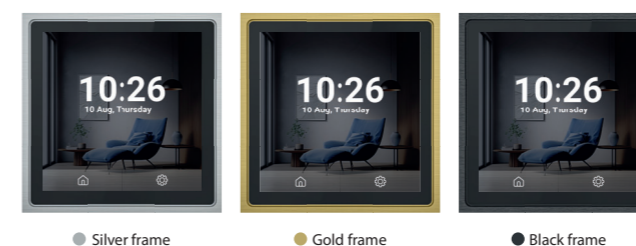

- FRM4H1.B INS4SQ Aluminium Frame sharp - Black
- FRM4H1.S INS4SQ Aluminium Frame sharp - Silver
- FRM4H1.G INS4SQ Aluminium Frame sharp - Gold
- FRM4P1.B INS4SQ Aluminium Frame curve - Black
- FRM4P1.S INS4SQ Aluminium Frame curve - Silver
- FRM4P1.G INS4SQ Aluminium Frame curve - Gold
- PS1M-15/24V Power supply



- The INS4RT is a sophisticated 4" touch panel that offers intuitive control for smart living spaces.
- It features a high-resolution IPS display, capacitive touchscreen, and is powered by an ARM A7 processor.
- The panel runs on Linux OS and supports up to 200 UI objects and 1000 BMS points.
- It's equipped with WiFi, Bluetooth, and RS485 connectivity, alongside built-in sensors for temperature and humidity.
- Is designed for seamless integration into modern home automation systems, providing users with a centralized interface for managing their environment.

Technical parameters INS4SQ-RT

Hardware / Software	
Hardware:	ARM A7 Single-Core 1.2 GHz / 128MB DDR3 Ram / 256 MB Nand flash
Software:	OS Linux 3.4
Display	
Type:	IPS 4" 480 x 480 resolution
Display:	400 cd/m2 luminance
Touch part:	5 Point capacitive touchscreen
Power Supply	
Supply voltage/tolerance:	24 VDC or 5V 2A (USB)
Dissipated power:	Power consumption max. 10W
Connection	
Standard Interfaces:	(1x) WIFI 802.11 b/g/n - 2.4Ghz / Bluetooth 4.0 (2x) Side RGB LED Bars (1x) 1 Watt Speaker (1x) RS485 up to 128 Node (1x) USB 2.0 Device
Built-in Sensors	
Humidity sensor:	range 0% up to 100% RH
Temperature sensor:	range -40°C up to +125°C
Operating conditions	
Working temperature:	-10°C – +50°C
Humidity:	5% – 90% at 25°C
Dimensions and weight	
Dimensions:	84 x 84 x 10,65 mm

Device description

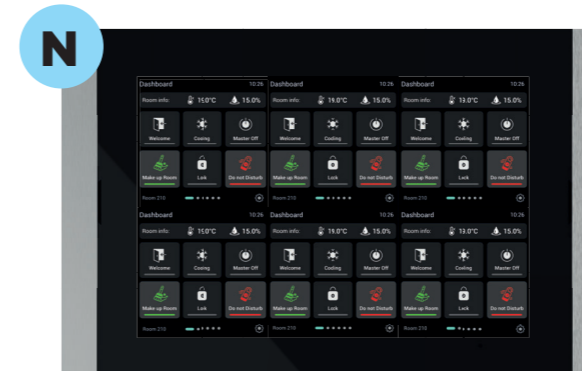

INS8SQ/B 8" Panel w/ Black Bars
INS8SQ/S 8" Panel w/ Silver Bars
INS8SQ/G 8" Panel w/ Gold Bars

INSPIA

Technical parameters INS8SQ

Hardware / Software	
Hardware:	Quad-Core 1.2 GHz / 1GB DDR3 Ram / 8GB Nand flash
Software:	OS Android 7.1 with iNELS application
Display	
Type:	IPS 8" 1280 x 800 re Via solution
Display:	300 cd/m2 luminance
Touch part:	5 point capacitive touchscreen
Power Supply:	
Supply voltage/tolerance:	24 VDC
PoE:	PoE IEEE 802.3at (optional w/PSU-TP-POE)
Dissipated power:	Power consumption max. 13W
Connection	
Ethernet:	1x LAN RJ45
Communication speed:	10/100 Mbps interface
Optional Interfaces	
	iNELS BUS
	RS485 (EIA-485) (RS4)
	Galvanic isolated RS485 Modbus (A-GMD)
	VRF mainline communication (A-VRM -or- A-VRR)
	Zigbee 3.0 (BCU-S24-ZGB -or- BCU-POE-ZGB)
Built-in Sensors	
Humidity sensor:	range 0% up to 100% RH
Temperature sensor:	range -40°C up-to +125°
Operating conditions	
Working temperature:	-10°C – +60°C
Humidity:	5% – 90% at 25°C
Dimensions and weight	
Dimensions:	243 x 149 x 42 mm
Standard:	EN 63044-1

Accessories

BOX-INS8Q	Flush Mount Box for 8" Touch Panel
BOX-INS8W	On-Wall Mount Box for 8" Touch Panel
PS1M-15/24V	Power supply

- The INS8SQ offers a feature-rich and versatile solution for control and monitoring applications, with its powerful hardware, user-friendly display, and support for various interfaces and sensors. Its temperature and humidity tolerance make it a reliable choice in different operating environments.
- Featuring IPS 8" 1280 x 800 resolution 350 cd/m2 luminance with 5 point capacitive touchscreen.
- The device runs on OS Android 6.0 operating system with A64 Quad-Core 1.3 GHz/1GB DDR3 Ram / 8GB Nand flash supporting up to 1000 BMS points.
- INS8SQ touch panel designed to control iNELS with Android OS via iNELS applications.
- Integrated speakers and microphone are primarily designed for intercom operation
- Integrated with essential sensors, the device includes an Ambient illuminance measurement sensor, humidity sensor and a temperature sensor, enabling efficient environmental monitoring.
- The INS8SQ comes with a standard LAN RJ45 10/100Mbps interface, ensuring easy network connectivity for data transfer and communication.
- The INS8SQ offers a variety of optional interfaces for enhanced connectivity and compatibility. These include iNELS, RS485, Modbus, VRF, and Zigbee 3.0
- The INS8SQ operates within a working temperature range of -10°C to +60°C.
- The device can be powered by either 24VDC, and it also supports Power over Ethernet (POE IEEE 802.3af), providing flexibility in power options max 30W.
- Configuration, programming, and update applications over the Skythings platform.

Device description

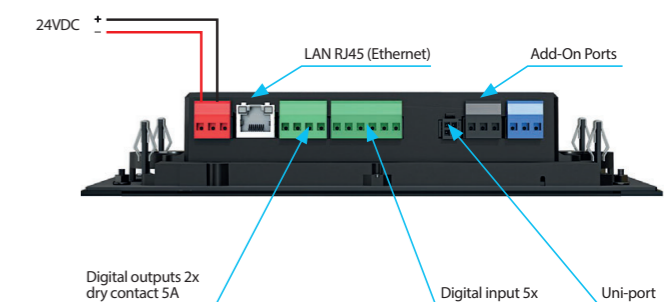

N

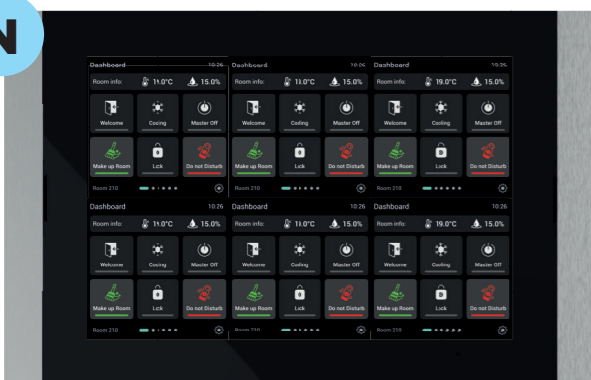

INS10SQ.B 10" Panel w/ Black Bars
INS10SQ.S 10" Panel w/ Silver Bars
INS10SQ.G 10" Panel w/ Gold Bars



Technical parameters INS10SQ

Hardware / Software

Hardware: Quad-Core 1.2 GHz / 1GB DDR3 Ram / 8GB Nand flash

Software: OS Android 7.1 with iNELS application

Display

Type: IPS 10" 1280 x 800 re Via solution

Display: 300 cd/m2 luminance

Touch part: 5 point capacitive touchscreen

Power Supply:

Supply voltage/tolerance: 24 VDC

PoE: PoE IEEE 802.3at (optional w/PSU-TP-POE)

Dissipated power: Power consumption max. 13W

Connection

Ethernet: 1x LAN RJ45

Communication speed: 10/100 Mbps interface

Optional Interfaces

iNELS BUS

RS485 (EIA-485) (RS4)

Galvanic isolated RS485 Modbus (A-GMD)

VRF mainline communication (A-VRM -or- A-VRR)

Zigbee 3.0 (BCU-S24-ZGB -or- BCU-POE-ZGB)

Built-in Sensors

Humidity sensor: range 0% up to 100% RH

Temperature sensor: range -40°C up-to +125°

Operating conditions

Working temperature: -10°C – +60°C

Humidity: 5% – 90% at 25°C

Dimensions and weight

Dimensions: 307 x 194.6 x 39.5 mm

Standard: EN 63044-1

Accessories

BOX-INS10Q Flush Mount Box for 10" Touch Panel
PS1M-15/24V Power supply

- The INS10SQ offers a feature-rich and versatile solution for control and monitoring applications, with its powerful hardware, user-friendly display, and support for various interfaces and sensors. Its temperature and humidity tolerance make it a reliable choice in different operating environments.
- Featuring IPS 10" 1280 x 800 resolution 350 cd/m2 luminance with 5 point capacitive touchscreen.
- The device runs on OS Android 6.0 operating system with A64 Quad-Core 1.3 GHz/1GB DDR3 Ram / 8GB Nand flash supporting up to 2000 BMS points.
- INS10SQ touch panel designed to control iNELS with Android OS via iNELS applications.
- Integrated speakers and microphone are primarily designed for inter-com operation
- Integrated with essential sensors, the device includes an Ambient illumination measurement sensor, humidity sensor and a temperature sensor, enabling efficient environmental monitoring.
- The INS10SQ comes with a standard LAN RJ45 10/100Mbps interface, ensuring easy network connectivity for data transfer and communication.
- The INS10SQ offers a variety of optional interfaces for enhanced connectivity and compatibility. These include iNELS, RS485, Modbus, VRF, and Zigbee 3.0
- The INS10SQ operates within a working temperature range of -10°C to +60°C.
- The device can be powered by either 24VDC, and it also supports Power over Ethernet (POE IEEE 802.3af), providing flexibility in power options max 30W.
- Configuration, programming, and update applications over the Skythings platform.

Device description

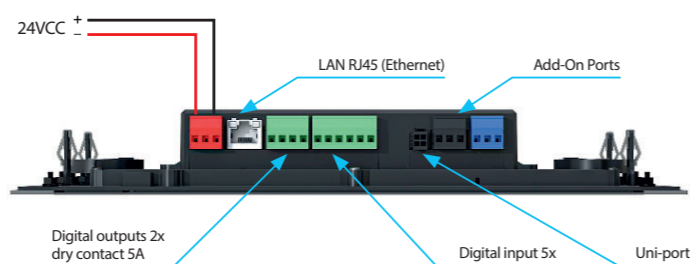

Technical parameters ADD-ONS

Order Code:	A-GRS4
Supported Media:	RS485
Power Consumption on Bus:	None
Isolation Type:	Board-to-board Galvanic Isolated
Dimensions:	35x30 mm



zigbee

Order Code:	A-ZGB
Supported Media:	Zigbee
Power Consumption on Bus:	None
Isolation Type:	None
Dimensions:	35x30 mm



iNELS

Order Code:	A-iBUS
Supported Media:	iNELS BUS
Power Consumption on Bus:	None
Isolation Type:	None
Dimensions:	35x30 mm

Technical parameters ADD-ONS

VRF & VRF SYSTEMS

Supported Brand	Order Code	Terminal Name	Communication Line
Samsung	A-VSM	F1-F2 / R1-R2	NASA
Daikin	A-VDK	F1-F2	D3 Net
Hitachi	A-VHT	1-2	TCC Link
LG	A-VLG	A-B	Inter A-B
Mitsubishi Electric	A-VME	M1-M2	M-Net TB3/7
Mitsubishi Heavy	A-VMH	A-B	S Slink I/II
Midea/Chigo	A-VMD	X-Y-E	X Y E
Panasonic/Sanyo	A-VPA	U1-U2	S3 Net
Toshiba	A-VTO	U1-U2	TCC Link

License

L-P100:	100 BMS Points License
L-P500:	500 BMS Points License
L-P1000:	1000 BMS Points License
L-VRF-U1:	1 Unit VRF License
L-VRF-C1:	1 Channel - 64 Unit VRF License
L-VRF-C2:	2 Channel - 128 Unit VRF License

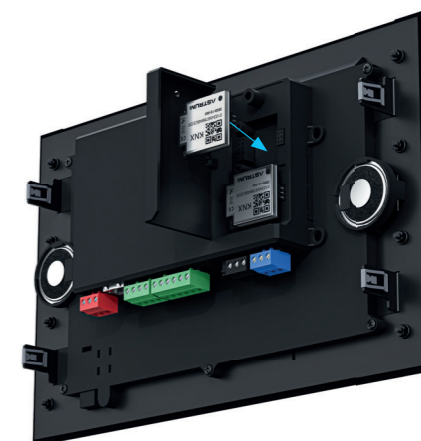



The BUS electro installation iNELS BUS System is a unique solution for electrical installation in the implementation of new projects of houses, villas, apartment buildings, office buildings, hotels, restaurants, wellness centres or perhaps even warehouse or production hall.

The ability to deploy this solution in such a wide variety of different buildings with various purposes and uses lies in its modularity. Thanks to the modular design, the system is very flexible and allows on the one hand, a solution of single-purpose tasks such as control of lighting in restaurants, and on the other hand, solving complex control systems for heating, ventilation, cooling, lighting and shading of office buildings. A complete range of control units designed from glass for management of hotel rooms is in the market unique. Thanks to its modularity is very easy to customize the size of the system and to that effect create a cost effective solution. Smart homes and buildings are accompanied by three basic ideas, namely savings, comfort and safety, the first two ideas may at first glance contradict each other. However, the main objective of smart home or building

equipped with the iNELS solution is to attain the optimum indoor environment while achieving the most efficient operation of all system. In homes and buildings the optimal internal environment is very important because people nowadays spend up to 80% of their time inside buildings. It is also shown that indoor environments, where we talk about thermal comfort, lighting comfort and indoor air quality significantly affect the mood and the effectiveness of people.

The iNELS system allows connection of wide range of sensors (temperature, light intensity, carbon dioxide, humidity, and pressure) and detectors (movement, opening doors and windows, gas leakage, smoke, flooding) whose values are constantly evaluated. At the same time iNELS allows the connection of all the technologies that are installed in the building, which continued to significantly increase operational efficiency or comfort, for example; in the case of integrating the guest room management system with the receptionist Fidelio system, which automatically during check-in, sends the room requests for execution, a welcome scene (optimum temperature, comfortable lighting scene, music etc.).

More systems can be controlled by iNELS:



Push-button wall controller



Glass wall controller



Temperature control



iNELS Cloud



Smartphone

What are the benefits of BUS controlling?

- Save energy by regulating lighting and heating properly
- Control of blinds, awnings, exterior or internal window shutters
- Dimming lights, lighting scenes
- control of appliances or electrical devices
- Control access gates, garage doors
- Logical and central functions (exit button, ...)
- Manual and automatic control mode
- Preventing undesirable opening of a window or a door
- Responding to the movement of people (authorized and unauthorized)
- Remote monitoring via smartphone, tablet or laptop
- Possibility to control via the iNELS Touch Panel 10"
- Integration of third-party devices (cameras, air conditioning, ...)

Problematic choice of suitable relay contact for a particular load switched with a product is described below. Mostly we experience problems with incorrect choice of load (meaning incorrect relay for a particular load) which results in permanent switching of contact (sealing) or damage on relay contact – which then results in malfunction. What load can you use? Detailed types of load according to standard EN 60947 are described in charts below – categories of use.

Category of use	Typical use	EN
AC current, $\cos\phi = P/S$ (-)		
AC-1	Non-inductive or slightly inductive load, resistance furnace Includes all appliances supplied by AC current with power factor ($\cos\phi$) ≥ 0.95 Examples of usage: resistance furnace, industrial loads	60947-4
AC-2	Motors with slip-ring armature, switching off	60947
AC-3	Motors with short-circuit armature, motor switching when in operation This category applies to switching off motors with short-circuit armature while in operation. While switching, contactor switches current which is 5 up to 7 times rated current of motor.	60947-4
AC-4	Electro-motors with short-circuit armature: start up, braking by backset, changeover	60947
AC-5a	Switching of electrical gas-filled lights, fluorescent lights	60947-4
AC-5b	El. bulb switching Enables low contact loading due to resistance of cold fiber is many times smaller than the one of hot fiber.	60947-4
AC-6a	Switching of transformers	60947-4
AC-6b	Switching of capacitors	60947-4
AC-7a	Switching low inductive loads of home appliances and similar applications	60947
AC-7b	Load of motors for home appliances	60947
AC-8a	Switching of hermetically sealed motors of cooling compressors with manual reset switches against overload Hermetically sealed cooling compressors have to be placed in one box without external shaft or shaft padding and motor must operate with cooling liquid	60947
AC-8b	Switching of hermetically sealed motors of cooling compressors with manual reset switches against overload Hermetically sealed cooling compressors have to be placed in one box without external shaft or shaft padding and motor must operate with cooling liquid	60947
AC-12	Switching of semiconductor loads with separation transformers	60947-5
AC-13	Switching of semiconductor loads with separation transformers	60947-5-1
AC-14	Switching of low electro-magnetic loads (max.72 VA)	60947-5-1
AC-15	Management of alternating electro-magnetic loads This category applies to switching inductive loads with input for closed electro-magnetic circuit higher than 72 VA Use: switching coils of contactors	60947-5
AC-20	Connecting and disconnecting in unloaded states	60947-3
AC-21	Switching resistive loads, including low loading	60947-3
AC-22	Switching of mixed resistive and inductive loads, including low overloading	60947-3
AC-23	Switching of motor loads or other high inductive loads	60947-3
AC-53a	Switching of motors with short-circuit armature with semiconductor contactors	60947

Note: Category AC 15 replaces formerly used category AC 11

DC current, $t = L/R$ (s)

DC-1	Non-inductive or low inductive load, resistive furnaces	60947-4
DC-3	Shunt motors: start-up, braking by backset, reversion, resistive braking	60947-4-1
DC-5	Series motor: start-up, braking by backset, reversion, resistive braking	60947-4-1
DC-6	Non-inductive or low inductive loads, resistive furnaces – el. bulbs	60947-4-1
DC-12	Management of resistive loads and fixed loads with insulation by opto-electric element	60947-5-1
DC-13	Switching of electromagnets	60947-5-1
DC-14	Switching of electromagnetic loads in circuits with limiting resistor	60947-5-1
DC-20a(b)	Switching and breaking without load(a: frequent switching ,b: occasional switching)	60947-3
DC-21a(b)	Switching ohmic loads including limiting overloading (a: frequent switching ,b: occasional switching)	60947-3
DC-22a(b)	Switching of compound ohmic and inductive loads including limited overloads (e.g. shunt motors) (a: frequent switching, b: random switching)	60947-3
DC-23	Switching of highly inductive loads (e.g. series motors)	60947-3

How can you distinguish for which load is our product (relay) designated?



















Our company record this information on a products and also in our catalogue, instruction manual and other promotional and technical material (website etc.). It is important to realize that it is not always possible to point out load because of lack of information about the device (user cannot measure $\cos\phi$) or it is not possible because of inconstancy of parameters of switched device. Manufacturer of relays records always guaranteed parameters in ideal conditions which are done by a norm (temperature, pressure, humidity, etc.) and reality can be in a lot of cases different. Category of use (classification) of a particular relay is done by material of output contacts.

Basic types of materials which are used for production of contacts for high-performance relay are:



















- AgCd – suitable for switching ohmic loads. Before of harmfulness of Cd, this type of contact is remitted.
- AgNi – designated for switching resistive loads, good quality switching and conducting (contact doesn't oxidate) small currents/voltages, it is not designated for surge currents and loads with inductive component.
- AgSn or AgSnO₂ – suitable for switching loads with inductive component, not suitable for switching small currents/voltages, it is more resistive to surge currents, suitable for DC voltage switching, less suitable for switching loads of ohmic type.
- Wf (wolfram)-special contact designated for switching surge currents with inductive component.
- with gold (AgNi/Au)- Used for "improving" contacts for low currents/ voltages , prevents oxidation.

Minimum load			Minimum load		
Relay contact	mV	V/mA	Relay contact	mV	V/mA
AgSnO ₂	1000	10/100	AgNi	300	5/10



















GCR3-11, GCH3-31, SA3-02B, SA3-06M, WMR3-21, SA3-014M, JA3-014M, RC3-610M/DALI, IOU3-108M

Type of load	 AC1	 AC2	 AC3	 AC5a uncompensated	 AC5a compensated	 AC5b	 AC6a	 AC7b	 AC12
Contact material AgSnO ₂ , contact 8 A	250 V/8 A	250 V/2.5 A	250 V/1.5 A	230 V/1.5 A (345 VA)	230 V/1.5 A (345 VA) till max output C=14uF	250 W	X	250 V/1 A	250 V/1 A
Type of load	 AC13	 AC14	 AC15	 DC1	 DC3	 DC5	 DC12	 DC13	 DC14
Contact material AgSnO ₂ , contact 8 A	250 V/3 A	250 V/3 A	250 V/3 A	24 V/4 A	24 V/2 A	24 V/1.5 A	24 V/4 A	24 V/1 A	24 V/1 A



















SA3-04M, SA3-022M (RE7 - RE-10), SA3-01B

Type of load	 AC1	 AC2	 AC3	 AC5a uncompensated	 AC5a compensated	 AC5b	 AC6a	 AC7b	 AC12
Contact material AgSnO ₂ , contact 16 A	250 V/16 A	250 V/3 A	250 V/2 A	230 V/3 A (690 VA)	230 V/3 A (690 VA) till max output C=14uF	1500 W	x	250 V/3 A	250 V/10 A
Type of load	 AC13	 AC14	 AC15	 DC1	 DC3	 DC5	 DC12	 DC13	 DC14
Contact material AgSnO ₂ , contact 16 A	250 V/6 A	250 V/6 A	250 V/6 A	24 V/8 A	24 V/4 A	24 V/3 A	24 V/8 A	24 V/2 A	24 V/2 A





SA3-02B/Ni*, SA3-06M/Ni*

Type of load	 AC1	 AC2	 AC3	 AC5a uncompensated	 AC5a compensated	 AC5b	 AC6a	 AC7b	 AC12
Contact material AgNi contact 8 A	250 V/8 A	250 V/1.5 A	250 V/1 A	230 V/1.5 A (345 VA)	x	400 W	x	250 V/0.5 A	250 V/5 A
Type of load	 AC13	 AC14	 AC15	 DC1	 DC3	 DC5	 DC12	 DC13	 DC14
Contact material AgNi contact 8 A	250 V/2 A	250 V/2 A	250 V/2 A	24 V/4 A	24 V/2 A	24 V/1.5 A	24 V/4 A	24 V/1 A	24 V/0.5 A







SA3-04M/Ni*

Type of load	 AC1	 AC2	 AC3	 AC5a uncompensated	 AC5a compensated	 AC5b	 AC6a	 AC7b	 AC12
Contact material AgNi contact 16 A	250 V/16 A	250 V/2.25 A	250 V/1.5 A	230 V/3 A (690 VA)	x	800 W	x	250 V/1 A	250 V/10 A
Type of load	 AC13	 AC14	 AC15	 DC1	 DC3	 DC5	 DC12	 DC13	 DC14
Contact material AgNi contact 16 A	250 V/4 A	250 V/4 A	250 V/4 A	24 V/8 A	24 V/4 A	24 V/3 A	24 V/8 A	24 V/2 A	24 V/1 A



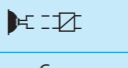









SA3-022M (RE1 - RE6, OUT1 - OUT2, RE11 - RE16, SHUTTER), EA3-022M (RE1 - RE6, OUT1 - OUT2, RE11 - RE16, SHUTTER), FA3-612M (FAN1 - FAN3, RE)

Type of load	 AC1	 AC3	 AC15	 DC1
Contact material AgNi contact 6 A	250 V/6 A	230 V/0.8 A	230 V/1.3 A	30 V/3 A 110 V/0.2 A 220 V/0.12 A

Demonstrated symbols are informative.
*Products with AgNi contact only up on request for extra charge.

Load	bulbs, halogen bulbs	12-24 V low-voltage bulbs, coil transformers	12-24 V low-voltage bulbs, electric transformers	LEDs/LED strip*	energy-saving fluorescent tubes	control method	
							
	R	L	C	dimnable	dimnable	entering edge	trailing edge
DA3-22M	•	•	•	•	•	•	•
DA3-66M	•	•	•	•	•	•	•
DA3-03M/RGBW	-	-	-	•	-	-	-

Explanations

	El. bulbs loads: el. bulb, halogen light	(R)		Elektronic ballasts for fluorescent	(L)
	Dimmer with defined load: R - resistive, L - inductive, C - capacitive			Inductive loads (transformers): feromagnetic and toroid transformers for lights with various voltage.	
	Fluorescent light: fluorescent lights uncompensated			Switch: switch - control contact of various device	
	Fluorescent light: fluorescent light compensated in series			Button: control button	
	Fluorescent light: fluorescent light compensated in parallel			Control module: analog control module 0 - 10 V	
	Fluorescent light: fluorescent light economical			Motor	

Category of use Typical use

AC current, $\cos \phi = P/S$ (-)

AC-1	Non-inductive or slightly inductive load, resistance furnace. Includes all appliances supplied by AC current with power factor ($\cos \phi$) ≥ 0.95 . Examples of usage: resistance furnace, industrial loads.
AC-2	Motors with slip-ring armature, switching off.
AC-3	Motors with short-circuit armature, motor switching when in operation. This category applies to switching off motors with short-circuit armature while in operation. While switching, contactor switches current, which is 5 up to 7 times rated current of motor.
AC-5a	Switching of electrical gas-filled lights, fluorescent lights.
AC-5b	El. bulb switching. Enables low contact loading due to resistance of cold fi ber is many times smaller that the one of hot fi ber.
AC-6a	Switching of transformers.
AC-7b	Load of motors for home appliances.
AC-12	Switching of semiconductor loads with separation transformers.
AC-13	Switching of semiconductor loads with separation transformers.
AC-14	Switching of low electro-magnetic loads (max. 72 VA).
AC-15	Management of alternating electro-magnetic loads. This category applies to switching inductive loads with input for closed electro-magnetic circuit higher than 72 VA. Use: switching coils of contactors. Note: Category AC 15 replaces formerly used category AC 11.

DC current, $t = L/R$ (s)

DC-1	Non-inductive or low inductive load, resistive furnaces.
DC-3	Shunt motors: start-up, braking by backset, reversion, resistive braking.
DC-5	Series motor: start-up, braking by backset, reversion, resistive braking.
DC-12	Management of resistive loads and fixed loads with insulation by opto-electric element.
DC-13	Switching of electromagnets.
DC-14	Switching of electromagnetic loads in circuits with limiting resistor.

ELKO EP as the manufacturer has the right to make technical changes to the product technical specification and product manual without prior notice.

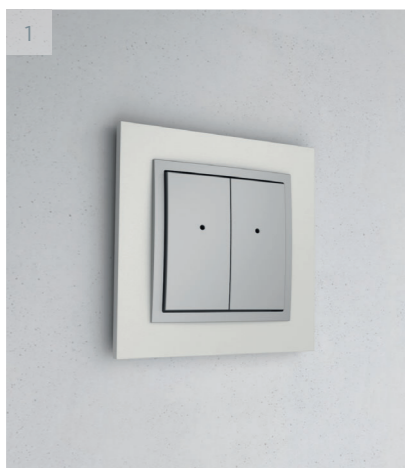

1) Surface mounted

Wall mounted in an installation box with spacing of 65 mm.

INS4SQ	GSB3-40/S	WSB3-20H
EHT3	GSB3-60/S	WSB3-40
GBP3-60x	GSB3-90/S	WSB3-40H
GCR3-11	MSB3-40	
GCH3-31	MSB3-60	
GRT3-50	MSB3-90	
GSB3-40	GSP3-100	
GSB3-60	GCR3-30	
GSB3-80	IDRT3-1	
GSB3-90	WMR3-21	
GSB3-20/S	WSB3-20	

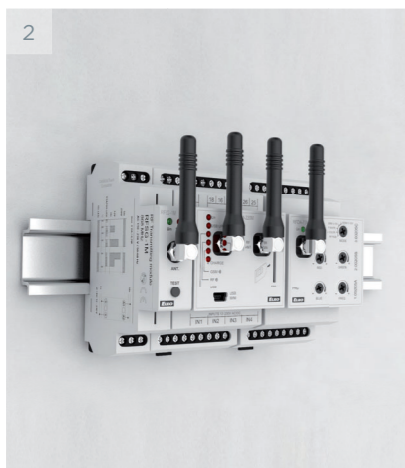

2) DIN Rail mounted

On DIN rail according to EN 60715.

ADC3-60M	PS3-100/iNELS
CU3-07M	SA3-04M
DA3-66M	SA3-06M
DA3-22M	SA3-014M
DAC3-04M	SA3-022M
FA3-612M	TI3-60M
IM3-140M	
IOU3-108M	
JA3-014M	
PS3-30/iNELS	

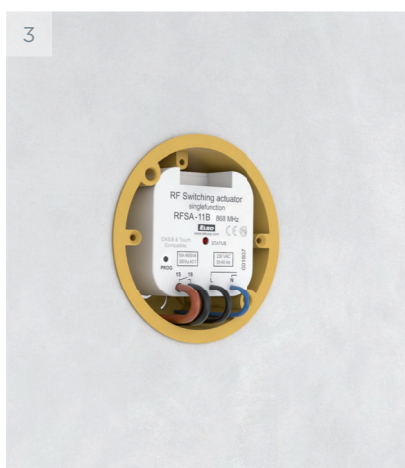

4) Mounted to or in the installation box

Mounted in an installation box or built into the device.

IM3-40B	SA3-01B
IM3-80B	SA3-02B
	TI3-40B



4) Mounted into the cover of appliance

SA3-01B
SA3-02B



5) Surface mounted

Other attachment options.

DLS3-1

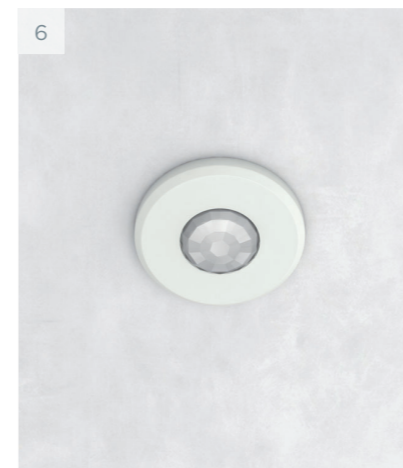

6) Ceiling mounting

MCD3-01
PMS3-01

1-MODULE

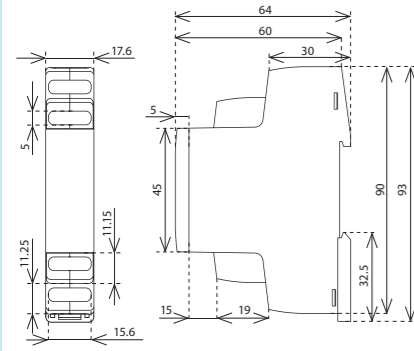

BPS3-01M
BPS3-02M
CU3-07M
CU3-08M
CU3-09M/DALI
CU3-10M/MODBUS
iNELS Bridge

3-MODULE

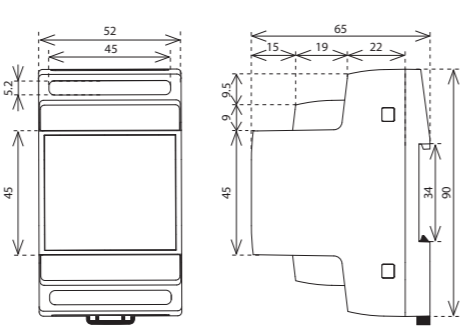

ADC3-60M PS3-30/iNELS
DA3-22M SA3-04M
DAC3-04M SA3-06M
IM3-140M TI3-60M
DA3-03M/RGBW

6-MODULE

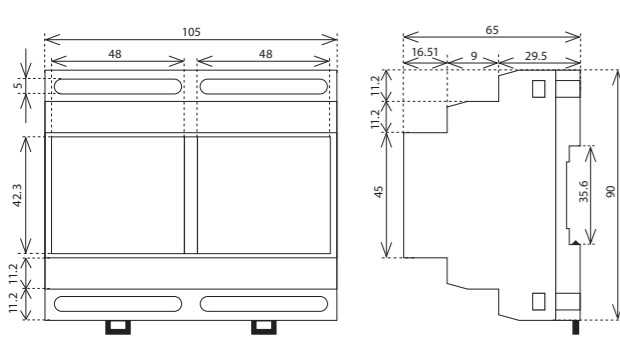

DA3-66M
EA3-022M
FA3-612M
IOU3-108M
JA3-014M
JA3-014M/E
SA3-014M
SA3-014M/E
SA3-022M
RC3-610M/DALI

BOX

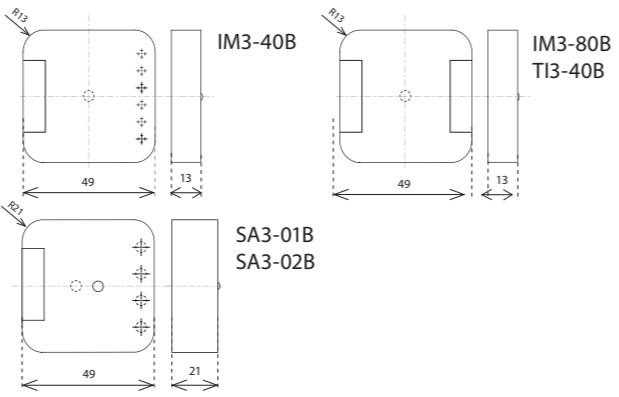

IM3-40B IM3-80B
TI3-40B
SA3-01B
SA3-02B

PSM3

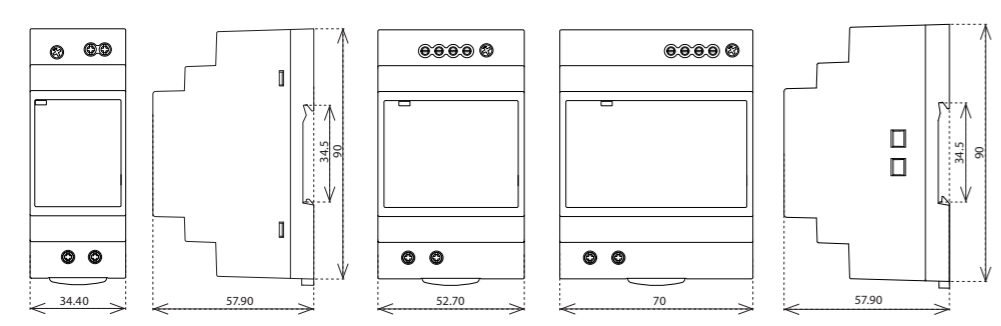

PSM3-30
PSM3-60
PSM3-100

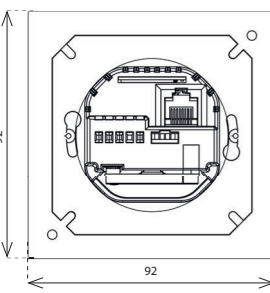

IN-S4SQ

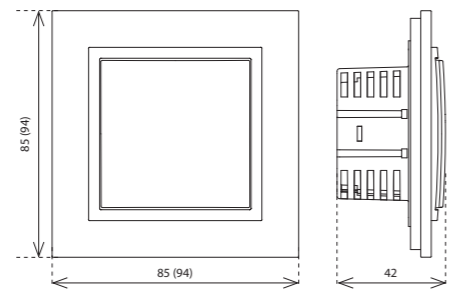

WSB3-20
WSB3-20H
WSB3-40
WMR3-21

IDRT3-1

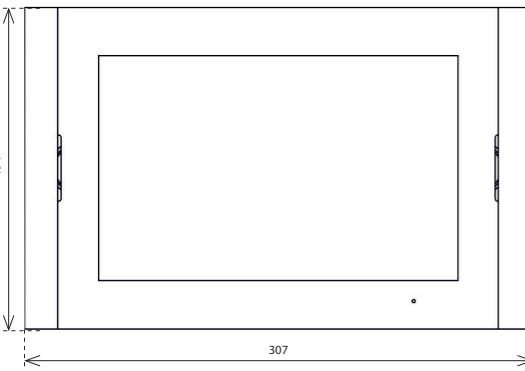

INS10SQ

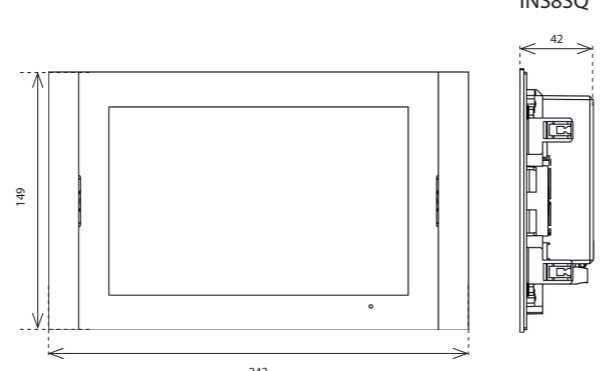

INS8SQ

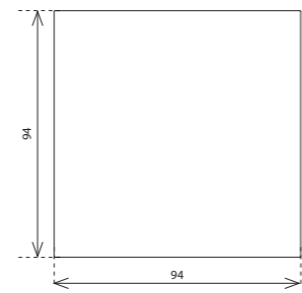

GCR3-11
GDB3-10
GRT3-50

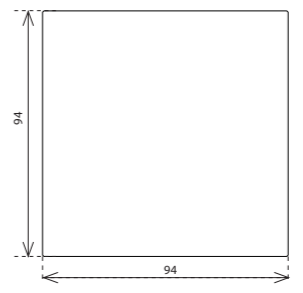

GSB3-40
GSB3-60
GSB3-90
GSB3-40/S
GSB3-60/S
GSB3-90/S
GRT3-70
MSB3-40
MSB3-60
MSB3-90
GCR3-30

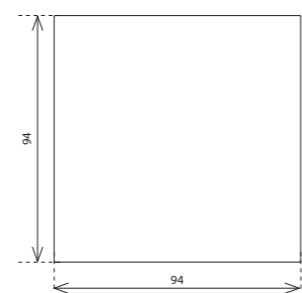

IN-S4SQ



GSP3-100
GCH3-31



GBP3-60x/2F

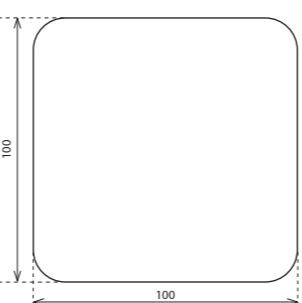

GRT3-270
GSB3-2x0
GSB3-2x0/S

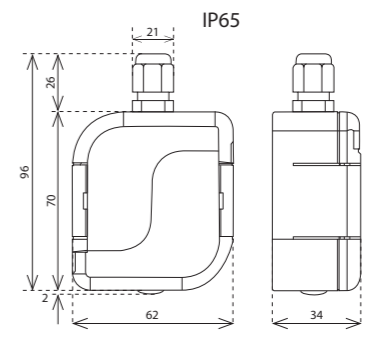

IP65

DLS3-1

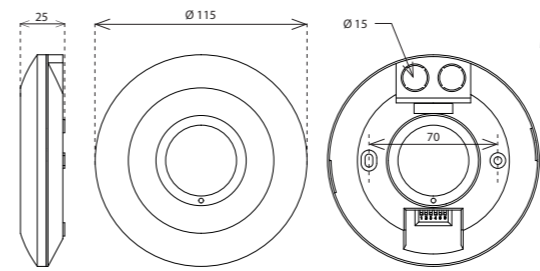

MCD3-01

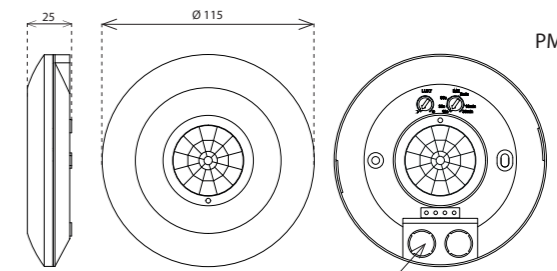

PMS3-01

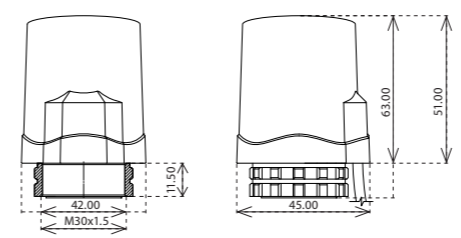

TELVA-2



● **Headquarters**

ELKO EP Holding SE, Czech Republic

● **Europe**

ELKO EP Balkan d.o.o
ELKO EP Bulgaria OOD
ELKO EP Germany GmbH
ELKO EP Hungary Kft.
ELKO EP POLAND Sp. z o.o.
ELKO EP SLOVAKIA, s.r.o.
ELKO EP UK Ltd.
ELKO EP UKRAINE LLC

● **Africa & Middle East**

ELKO EP Egypt LLC
ELKO EP Kuwait Ltd.
ELKO EP MEA LLC
ELKO EP Saudi Arabia Ltd.
ELKO EP South Africa PTY
Ltd.

● **America**

ELKO EP North America LLC



ELKO EP, s.r.o. | Palackeho 493 | 769 01 Holesov, Vsetuly | Czech Republic
phone: +420 573 514 221 | fax: +420 573 514 227 | elko@elkoep.com | www.elkoep.com

Published: 11/2024 | Modifications or amendments reserved | © Copyright ELKO EP, s.r.o. | 1st edition